

Xantrex™ XW MPPT 80 600

Operation Guide

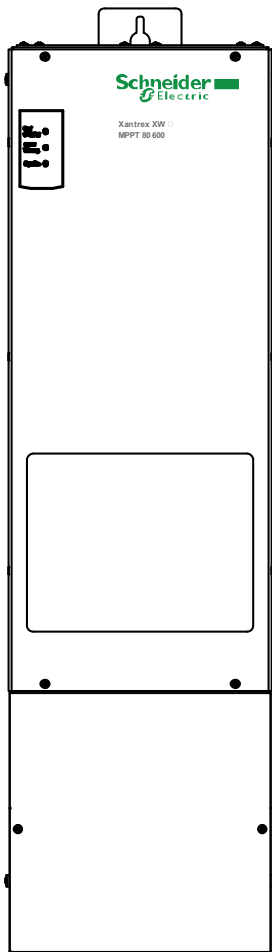

Xantrex XW MPPT 80 600

Operation Guide

Trademarks

Schneider Electric, the **Schneider Electric logo**, **Xantrex**, and **Xanbus** are trademarks or registered trademarks of the Schneider Electric group of companies. Other trademarks, registered trademarks, and product names are the property of their respective owners and are used herein for identification purposes only.

Notice of Copyright

Copyright © 2010 Xantrex Technology Inc. All rights reserved. No part of this document may be reproduced in any form or disclosed to third parties without the express written consent of:

Xantrex Technology Inc.

161-G South Vasco Road

Livermore, California USA 94551

Xantrex Technology Inc. reserves the right to revise this document and to periodically make changes to the content hereof without obligation or organization of such revisions or changes unless required to do so by prior arrangement.

Exclusion for Documentation

UNLESS SPECIFICALLY AGREED TO IN WRITING, XANTREX TECHNOLOGY INC. ("XANTREX")

(A) MAKES NO WARRANTY AS TO THE ACCURACY, SUFFICIENCY OR SUITABILITY OF ANY TECHNICAL OR OTHER INFORMATION PROVIDED IN ITS MANUALS OR OTHER DOCUMENTATION;

(B) ASSUMES NO RESPONSIBILITY OR LIABILITY FOR LOSSES, DAMAGES, COSTS OR EXPENSES, WHETHER SPECIAL, DIRECT, INDIRECT, CONSEQUENTIAL OR INCIDENTAL, WHICH MIGHT ARISE OUT OF THE USE OF SUCH INFORMATION. THE USE OF ANY SUCH INFORMATION WILL BE ENTIRELY AT THE USER'S RISK; AND

(C) REMINDS YOU THAT IF THIS MANUAL IS IN ANY LANGUAGE OTHER THAN ENGLISH, ALTHOUGH STEPS HAVE BEEN TAKEN TO MAINTAIN THE ACCURACY OF THE TRANSLATION, THE ACCURACY CANNOT BE GUARANTEED. APPROVED XANTREX CONTENT IS CONTAINED WITH THE ENGLISH LANGUAGE VERSION WHICH IS POSTED AT WWW.SCHNEIDER-ELECTRIC.COM.

Date and Revision





November 2010 Revision A

Part Number

975-0560-01-01

Contact Information

www.schneider-electric.com

|  |  |  |  |
|-------------------------------------------------------------------------------------|-------------------------------------------------------------------------------------|-------------------------------------------------------------------------------------|----------------------------------------------------------------------------------------------------------------|
| North America | 1 650 351 8237 1 866 519 1470 | 1 925 245 1022 | re.techsupport@schneider-electric.com |
| France | 0 825 012 999 | | fr-re-techsupport@fr.schneider-electric.com |
| Deutschland | +49 (0) 180 575 3 575 | +49 (0) 2102 404 7101 | pv-service@de.schneider-electric.com |
| España | +34 902 101 813 | +34 933 055 026 | es-sat@es.schneider-electric.com |
| L'Italia | +39 035 4151111 | +39 035415 3200 | IT-pronto-contatto@it.schneider-electric.com |

For other country details please contact your local Schneider Electric Sales Representative or visit our website at: <http://www.schneider-electric.com/sites/corporate/en/support/operations/local-operations/local-operations.page>

About This Guide

Purpose

The purpose of this Guide is to provide explanations and procedures for configuring, operating, and troubleshooting the Schneider Electric Xantrex XW MPPT 80 600.

Scope

This Guide provides safety guidelines as well as information about operating, configuring, and troubleshooting the unit. It does not provide details about particular brands of photovoltaic (PV) panels or batteries.

Audience

This Guide is intended for anyone who needs to operate the unit. Operators must be familiar with all the safety regulations pertaining to operating high-voltage equipment as dictated by local code. Operators must also have a complete understanding of this equipment's features and functions. Do not use this product unless it has been installed by qualified personnel in accordance with the instructions in the Xantrex XW MPPT 80 600 Installation Guide (Document Part Number 975-0540-01-01).

Only qualified personnel should perform the installation, configuration, commissioning, and maintenance of the unit.

Organization

This Guide is organized into four chapters and three appendices:

- Chapter 1 describes features and functionality of the Xantrex XW MPPT 80 600.
- Chapter 2 contains information and procedures to configure the Xantrex XW MPPT 80 600.
- Chapter 3 contains information about operating the Xantrex XW MPPT 80 600.
- Chapter 4 contains information about identifying and resolving possible problems that may arise while using a Xantrex XW MPPT 80 600.
- Appendix A provides the specifications for the Xantrex XW MPPT 80 600.
- Appendix B is a guide to the Xantrex XW MPPT 80 600 monitoring and configuration menus on the Xantrex XW System Control Panel.
- Appendix C provides information on Boost Charging for flooded lead-acid batteries in off-grid applications.

Conventions Used

This Guide uses the term “unit” to refer to the Xantrex XW MPPT 80 600.

This Guide uses the following conventions for conveying important safety related information:

| |
|-------------------------------------------------------------------------------------------------------------------|
| ⚠ DANGER |
| DANGER indicates an imminently hazardous situation which, if not avoided, will result in death or serious injury. |

| |
|-------------------------------------------------------------------------------------------------------------------|
| ⚠ WARNING |
| WARNING indicates a potentially hazardous situation which, if not avoided, can result in death or serious injury. |

| |
|--------------------------------------------------------------------------------------------------------------------|
| ⚠ CAUTION |
| CAUTION indicates a potentially hazardous condition which, if not avoided, can result in minor or moderate injury. |

| |
|--------------------------------------------------------------------------------------------------------------------------------------------|
| CAUTION |
| CAUTION without the exclamation symbol indicates a potentially hazardous situation, which, if not avoided, can result in equipment damage. |

| |
|-------------------------------------------------------------------------|
| NOTICE |
| NOTICE indicates important information that you need to read carefully. |

Important: These notes describe things which are important for you to know, but they are not as serious as a notice, caution, warning, or danger.

Abbreviations and Acronyms

| | |
|------|----------------------------------------------------------------------------------------------------------------------------------------------------------------------------------------------------------|
| CSA | Canadian Standards Association |
| DC | Direct Current |
| FCC | Federal Communications Commission |
| GFP | Ground Fault Protection |
| ISC | Short circuit current rating of an PV panel under STC |
| LCD | Liquid Crystal Display |
| LED | Light Emitting Diode |
| MPP | Maximum Power Point |
| MPPT | Maximum Power Point Tracking |
| MSDS | Material Safety Data Sheet |
| PV | Photovoltaic |
| STC | Standard Test Conditions specific to photovoltaic panels (1000 W/m ² , light spectrum AM 1.5 and 25 °C); panel nameplate ratings are based on STC and may be exceeded under other conditions. |
| UL | Underwriters Laboratories |
| VAC | Volts AC |
| VDC | Volts DC |
| VMPP | Voltage at Maximum Power Point |
| VOC | Open circuit voltage rating of a PV panel under STC |

Related Information

You can find information about installing the unit in the Xantrex XW MPPT 80 600 Installation Guide (Document Part Number 975-0540-01-01). It is provided with the unit and is also available at www.schneider-electric.com.

You can find more information about Schneider Electric as well as its products and services at www.schneider-electric.com.

Important Safety Instructions

General Safety Instructions

DANGER

HAZARD OF SHOCK, BURN, FIRE, AND EXPLOSION

This Guide contains important safety instructions that should be followed during the operation and maintenance of the Xantrex XW MPPT 80 600. Be sure to read, understand, and save these safety instructions.

- All electrical work must be done in accordance with local electrical codes.
- To be installed and serviced only by qualified personnel equipped with appropriate personal protective equipment and following safe electrical work practices.
- Energized from multiple sources. Before removing covers, consult system diagram to identify all sources; de-energize, lock out, and tag out; and wait for two minutes for internal capacitors to discharge to a safe voltage.
- Before servicing, test using a meter rated at least 1000 VDC to make sure all circuits are de-energized.
- Provided with integral PV ground fault protection. Normally grounded conductors may be ungrounded and energized when a ground fault is indicated. Integral ground fault detection fuse is located under wiring compartment cover. Disconnect all sources of power before opening.

Failure to follow these instructions will result in death or serious injury.

WARNING

LIMITATIONS ON USE

The Xantrex XW MPPT 80 600 is not intended for use in connection with life support systems or other medical equipment or devices.

Failure to follow these instructions can result in death or serious injury.

Battery Safety Information

⚠ DANGER

HAZARD OF ELECTRIC SHOCK, BURN, FIRE, AND EXPLOSION

Batteries contain corrosive electrolyte and can give off explosive gases. Battery circuits present a shock and energy hazard. Observe proper precautions when working with batteries and battery circuits:

- Always wear eye protection when working with batteries.
- Remove all jewelry before performing electrical work.
- Install batteries in a well-ventilated area to help prevent the possible buildup of explosive gases.
- Do not mix battery types.
- Do not smoke in the vicinity of a battery.
- Use insulated tools when working with batteries.
- When connecting batteries, always verify proper voltage and polarity.
- Do not short-circuit the battery.
- Always use proper lifting techniques when handling batteries.

Failure to follow these instructions will result in death or serious injury.

For full installation instructions and safety information, see the documentation provided with the batteries. Consult the MSDS for the batteries for first aid procedures, emergency procedures, and clean-up instructions.

FCC Information to the User

This equipment has been tested and found to comply with the limits for a Class B digital device, pursuant to part 15 of the FCC Rules and to Industry Canada ICES-003. These limits are designed to provide reasonable protection against harmful interference when the equipment is operated in a residential environment. This equipment generates, uses, and can radiate radio frequency energy and, if not installed and used in accordance with the installation and operation guides, may cause harmful radio frequency interference with radio communications. However, there is no guarantee that interference will not occur in a particular installation. If this equipment does cause harmful interference with radio or television reception, which can be determined by turning the equipment off and on, the user is encouraged to try to correct the interference by one or more of the following measures:

- Reorient or relocate the receiving antenna.
- Increase the separation between the equipment and the receiver.
- Connect the equipment to a different circuit from that to which the receiver is connected.
- Consult the dealer or an experienced radio or TV technician for help.

Contents

Important Safety Instructions-----vii

1 Introduction

| | |
|----------------------------------|-----|
| Features | 1-2 |
| Maximum Power Point Tracking | 1-3 |
| Charge Control | 1-4 |
| Three-Stage Battery Charging | 1-4 |
| Bulk Stage | 1-4 |
| Absorption Stage | 1-4 |
| Float Stage | 1-5 |
| Two-Stage Battery Charging | 1-6 |
| Battery Temperature Compensation | 1-7 |
| Equalization Charging | 1-8 |
| Auxiliary Output Functions | 1-8 |

2 Configuration

| | |
|----------------------------------------------------------|------|
| Configuring the Unit | 2-2 |
| Selecting a Unit | 2-2 |
| Viewing Basic and Advanced Settings | 2-2 |
| Modifying Configurable Settings | 2-3 |
| Configuring Battery Characteristics and Battery Charging | 2-3 |
| Setting a Custom Battery Type | 2-6 |
| Battery Temperature Compensation | 2-7 |
| Configuring Peak Power Tracking | 2-7 |
| Configuring the Auxiliary Output | 2-8 |
| Trigger Source Descriptions | 2-11 |
| Trigger Source Configurable Ranges | 2-12 |
| Configuring Device Settings | 2-13 |
| Reducing Tare Loss | 2-15 |
| Resetting to Factory Defaults | 2-15 |

3 Operation

| | |
|----------------------------------------------------------|-----|
| Viewing Status Information on the Xantrex XW MPPT 80 600 | 3-2 |
| Viewing Status on the Xantrex XW System Control Panel | 3-3 |
| Normal Operation | 3-3 |
| Charge Stages | 3-4 |
| Viewing Active Faults, Errors, and Warnings | 3-4 |
| Faults | 3-6 |
| Errors | 3-7 |
| Warnings | 3-9 |

| | |
|-------------------------------------------------------|------|
| Viewing Fault, Error, and Warning Logs | 3-11 |
| Fault and Error Logs | 3-11 |
| Warning Logs | 3-11 |
| Viewing Harvest Logs | 3-11 |
| Daily Logs | 3-12 |
| Monthly Logs | 3-12 |
| Yearly Logs | 3-12 |
| Equalizing Batteries | 3-12 |
| 4 Troubleshooting | |
| Troubleshooting | 4-2 |
| A Specifications | |
| Electrical Specifications | A-2 |
| MPPT Voltage Range | A-3 |
| Operating Below the PV Array Voltage Full Power Range | A-3 |
| Default Battery Charging Settings | A-4 |
| Mechanical Specifications | A-5 |
| Output Power Versus Ambient Temperature | A-5 |
| Recommended Accessories | A-6 |
| Optional Accessories | A-6 |
| Regulatory Approvals | A-6 |
| B Xantrex XW System Control Panel Menus | |
| Using the Xantrex XW SCP | B-2 |
| Xantrex XW SCP Menu Map | B-3 |
| Changing Settings Using the Xantrex XW SCP | B-4 |
| Viewing the Select Device Menu | B-5 |
| Viewing the Setup Menu | B-5 |
| The Setup Menu | B-6 |
| Configuration Settings | B-7 |
| Monitoring the Unit | B-10 |
| Home Screen | B-10 |
| Meters | B-11 |
| C Boost Charging | |
| Using Boost Charging | C-2 |
| Warranty and Return Information | WA-1 |
| Index | IX-1 |

1

Introduction

Chapter 1 describes features and functionality of the Xantrex XW MPPT 80 600.

| For information on: | See: |
|--------------------------------|-------------|
| "Features" | page 1-2 |
| "Maximum Power Point Tracking" | page 1-3 |
| "Charge Control" | page 1-4 |
| "Auxiliary Output Functions" | page 1-8 |

Features

The Xantrex XW MPPT 80 600 is a photovoltaic charge controller that tracks the maximum power point of a PV array to deliver the maximum available current for optimum charging of batteries. The unit can be used with 24 and 48 VDC battery systems only.

The unit is designed to regulate the available power from a PV source only. It is not designed to regulate power from other types of power sources.

The unit can be installed (in single or multi-unit configurations) with a Xantrex XW Hybrid Inverter/Charger or as a stand alone battery charger. However, it is recommended that, at minimum, a Xantrex XW System Control Panel (Xantrex XW SCP) or Xantrex Gateway be included in the system (see “Recommended Accessories” and “Optional Accessories” on page A-6 for product part numbers). The Xantrex XW SCP provides both status information and the ability to change settings, while the Xantrex Gateway (access via a personal computer) provides status only.

Standard features of the Xantrex XW MPPT 80 600 include:

- Five-year limited warranty.
- Two- or three-stage charging process, with manual equalization to maximize system performance and maintain expected battery life.
- Maximum Power Point Tracking (MPPT) to deliver the maximum available power from a PV array to a bank of batteries. See “Maximum Power Point Tracking” on page 1-3.
- Integrated PV Ground Fault Protection (PV GFP).
- Fan-cooled with speed control based on internal (heat sink) temperature.
- 80 amp charging current capability.
- Configurable auxiliary output. See “Auxiliary Output Functions” on page 1-8.
- Three LEDs for displaying operating status (On/Charging, Equalize, and Error/Warning).
- Input over-voltage protection, output over-voltage protection, output under-voltage protection, and output over-current protection. Warnings, errors, and faults are indicated by the red LED. View the associated warning or error message on the Xantrex XW System Control Panel (Xantrex XW SCP).
- Xantrex Xanbus™-enabled. Xantrex Xanbus is a network communications protocol developed by the manufacturer. The unit is able to communicate its settings and activity to other Xantrex Xanbus-enabled devices, such as the Xantrex XW Hybrid Inverter/Charger, the Xantrex XW System Control Panel (Xantrex XW SCP), the Xantrex XW Automatic Generator Start, and other units.

- Over-temperature protection and power derating of output power when ambient temperature is high.
- Battery Temperature Sensor (BTS) to provide automatic temperature-compensated voltage setpoints for battery charging. If the BTS is lost or damaged, a replacement can be ordered from the manufacturer (part number 808-0232-02).

Maximum Power Point Tracking

Maximum Power Point Tracking (MPPT) allows the unit to harvest the maximum energy available from the PV array and deliver it to the batteries. The MPPT algorithm continuously adjusts the operating voltage of the array to find the maximum power point. Input power is measured and compared to the amount of input power harvested at the previous operating voltage. The next adjustment to the operating voltage is dependent upon whether the unit harvested more or less power than it did at the previous operating voltage.

The algorithm is implemented by applying a variable load on the array—shown by the power curve (solid line) in Figure 1-1—until it finds the peak power (the point at which the combination of the operating voltage and current is maximized), as indicated by **MPP** in Figure 1-1. The unit will continue adjusting the operating voltage to stay on the maximum power point. This is necessary as the **MPP** changes throughout the day due to panel temperature, panel shading, and sunlight intensity. This happens without interruption of output power flow to the batteries.

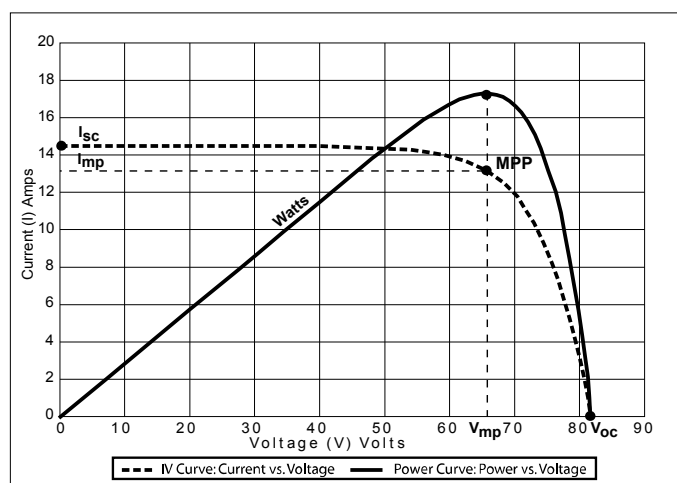

Figure 1-1 Maximum Power Point Curve

Charge Control

The unit can regulate PV array current at an appropriate level for 24 or 48 V batteries. It produces up to 80 amps of charging current for both battery voltages up to 2560 watts (24 V) or 4800 watts (48 V).

The unit controls how the batteries are charged by the DC source (the PV array). It can be configured to use a two-stage (no float) or three-stage charging process to maintain battery voltage at bulk, absorption, or float levels. When charging, the unit regulates the battery voltage and the output current based on the amount of DC power available from the PV array and the state of charge of the battery.

Three-Stage Battery Charging

The three-stage battery charging process results in more efficient charging compared to on-off relay type or constant voltage solid-state regulators. The final float stage reduces battery gassing, minimizes electrolyte loss, and ensures complete battery recharging. Battery voltage and current vary during the three-stage charging process as shown in Figure 1-2 on page 1-5.

Bulk Stage

During the bulk stage, the unit operates in constant current mode, delivering the maximum current to the batteries (or the maximum current available if the PV does not have enough power to provide maximum current). When the battery voltage reaches the absorption voltage setting, the controller will transition to the absorption stage.

Absorption Stage

During the absorption stage, the unit begins operating in constant voltage mode and the current falls gradually as the amp hours are returned to the battery. The voltage limit used for the first 60 minutes of this stage is the bulk voltage setting. The voltage limit used for the remaining time in this stage is the absorption voltage setting. By default, the bulk voltage setting and the absorption voltage setting are the same for all battery types.

The default voltage limit settings (bulk and absorption) can be adjusted if the battery type is set to Custom (see “Setting a Custom Battery Type” on page 2-6). For flooded lead acid batteries only, a custom charging scheme can be used which sets the bulk voltage higher than the absorption voltage. The result of this is a boost voltage charge level, which has been found to be beneficial for ensuring enough amp hours are returned to the battery bank for off-grid installations. For detailed information on how boost charging works and when it is recommended, see Appendix C, “Boost Charging”.

The unit transitions to the float stage if either of two conditions are met:

- The charge current allowed by the batteries falls below the exit current threshold, which is equal to 2% of the programmed battery capacity (for a 500 amp-hour battery bank, this would be 10 amps), for one minute.
- The unit has been in absorption for the programmed maximum absorption time limit. The default is three hours, but the time limit is programmable from one minute to eight hours.

Float Stage

During the float stage, the voltage of the battery is held at the float voltage setting. Full current can be provided to the loads connected to the battery during the float stage from the PV array. When battery voltage drops below the recharge voltage setting for one minute, a new bulk cycle is triggered.

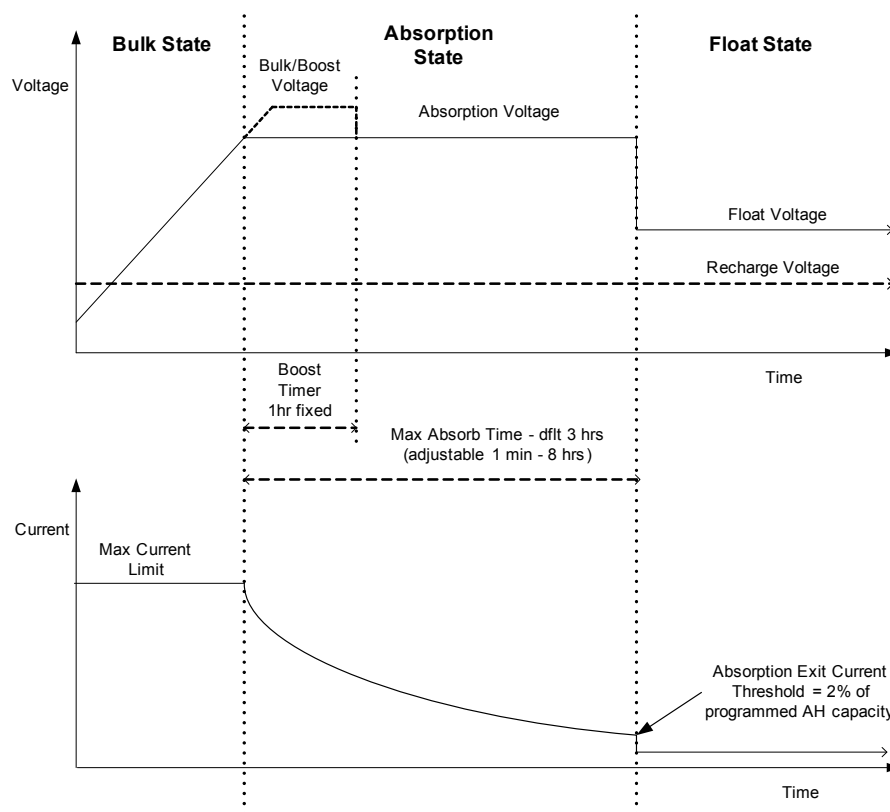

Figure 1-2 Three-stage Battery Charging Cycle^a

a. The charging cycle of the unit may differ from the curves shown above due to the amount of solar energy available and any DC loads present on the battery system during charge.

Important: This note is applicable to Figure 1-2 and Figure 1-3.

1. When the charge cycle is interrupted, the unit will resume charging at the beginning of the multi-stage algorithm.
 2. Exit current threshold can be disabled by programming the amp-hour capacity to 0. In this case, absorption will only exit when the absorption timer expires.
 3. Charge current during the equalize state (an optional state not shown here) is normally limited to 10% of the programmed amp-hour capacity setting. If this setting is programmed to 0 Ah, the charge current during equalize is limited to what is programmed for the maximum current limit of the unit (default is 80 A).
 4. Synchronized charge states are active when more than one charging device (the unit or Xantrex XW Hybrid Inverter/Charger) is connected in the battery system and a common Xantrex Xanbus network.
 - a) The first charging device to enter bulk causes all other devices to enter bulk.
 - b) The first charging device to enter absorption causes all other devices to enter absorption.
 - c) The last Xantrex XW Hybrid Inverter/Charger that is ready to exit absorption triggers all devices to exit absorption and enter float.
-

Two-Stage Battery Charging

The two-stage charging process includes the bulk and absorption stages only. There is not a float stage. The relationship between charging current and battery voltage during the two-stage charging process is shown in Figure 1-3.

No Float State

During the no float state the unit does not produce any charge current. Instead, the unit monitors the battery voltage and transitions back to the bulk stage once the voltage drops below the recharge voltage setting for one minute.

Important: For more information about battery charging settings, see Table 2-1, “Battery Configuration Settings” on page 2-4 and Table 2-2, “Custom Battery Settings” on page 2-6.

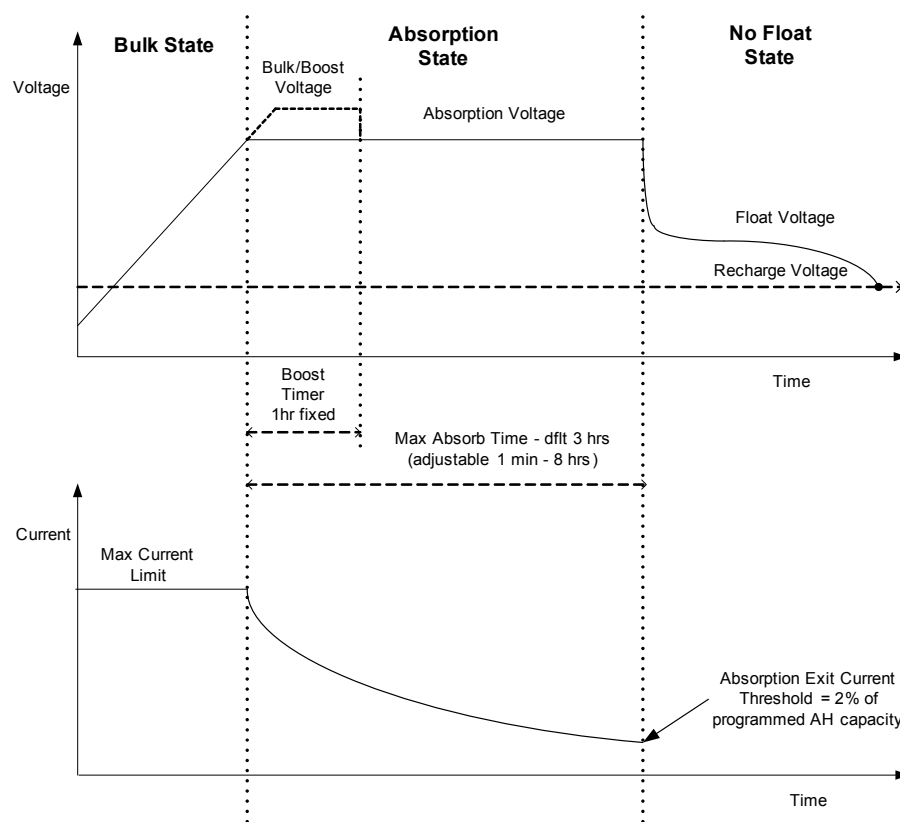

Figure 1-3 Two-Stage Battery Charging Cycle

Battery Temperature Compensation

The Battery Temperature Sensor (BTS) provides temperature-compensation for battery charging. With the BTS installed, the unit adjusts charging voltage with the temperature of the battery to optimize the charge delivery and help prolong battery life. The BTS also provides over-temperature protection for the batteries.

The BTS plugs into the BTS RJ-11 port located inside the wiring compartment of the unit. The BTS can be installed on the negative battery post, on the positive battery post, or on the side of the battery case. See “Installing the Battery Temperature Sensor” in the Xantrex XW MPPT 80 600 Installation Guide (Document Part Number 975-0540-01-01).

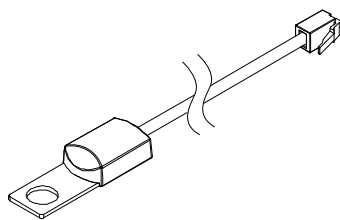

Figure 1-4 Battery Temperature Sensor

If the BTS is not installed, the voltage settings for charging are based on one of three temperature settings (Cold, Warm, or Hot) available on the Charger Settings menu. See “Configuring Battery Characteristics and Battery Charging” on page 2–3.

Only one BTS is required per battery bank if multiple units or a complete Xantrex XW Power System with Xantrex XW Hybrid Inverter/Chargers are networked together using Xantrex Xanbus. All networked Xantrex XW Series devices share battery temperature information, and the BTS can be connected to a unit or a Xantrex XW Hybrid Inverter/Charger. If more than one BTS is used within the system, the highest reported temperature from all of the units with an attached BTS will be used as the battery temperature for the temperature compensation value of the battery charge algorithm.

Equalization Charging

The unit can be used to provide the battery bank with an equalize charge. Equalization is a deliberate overcharge designed to return each battery cell to optimum condition by reducing sulfation and stratification in the battery. The equalization charge is generally performed only on flooded, vented (non-sealed or “wet”) lead-acid batteries, as recommended by the battery manufacturer.

To avoid damaging your batteries be sure to read, understand, and follow all cautions and warnings concerning equalization charging. For more information, see “Equalizing Batteries” on page 3–12.

Auxiliary Output Functions

The unit has a set of auxiliary relay contacts—one normally opened (NO) and one normally closed (NC)—that can be used to drive a relay for load control or to turn on devices such as vent fans or indicator alarms. The auxiliary output can be configured to trigger under only one condition at a time. See “Configuring the Auxiliary Output” on page 2–8 for information about auxiliary output trigger sources and how to enable and configure the auxiliary output for your application.

- | | |
|---------------------|------------------------------------------------------------------------------------------------------------------------------------------------------------------------------------------------------------------------------------------------------------------------------------------------------------------|
| Load Control | The unit's auxiliary output can be configured to disconnect or reconnect loads depending on battery voltage. This load control function enables the unit to help prevent damage to the battery from over-discharge during periods of poor charging (due to ambient temperature, for example) or excessive loads. |
| Vent Fan | The unit's auxiliary output can be configured to trigger a small DC fan to clear a battery compartment of harmful gases. The unit's auxiliary output must be configured to activate when flooded batteries reach their gassing voltage. |
| Alarms | The auxiliary output can be configured to trigger an alarm or indicator light when a pre-set condition occurs, such as low or high battery voltage, high PV array voltage, or a unit error condition. |

2

Configuration

Chapter 2 contains information and procedures to configure the Xantrex XW MPPT 80 600.

| For information on: | See: |
|------------------------------------------------------------|-------------|
| "Configuring the Unit" | page 2-2 |
| "Configuring Battery Characteristics and Battery Charging" | page 2-3 |
| "Configuring Peak Power Tracking" | page 2-7 |
| "Configuring the Auxiliary Output" | page 2-8 |
| "Configuring Device Settings" | page 2-13 |
| "Reducing Tare Loss" | page 2-15 |
| "Resetting to Factory Defaults" | page 2-15 |

Configuring the Unit

Configure the unit using the Xantrex XW System Control Panel (Xantrex XW SCP). See Appendix B, “Xantrex XW System Control Panel Menus” for an overview of the Xantrex XW SCP, or view the entire Xantrex XW SCP Owner’s Guide (Document Part Number 975-0298-01-01) at www.schneider-electric.com.

Selecting a Unit

Before you can configure the unit’s settings, you must select the unit’s device number in the Xantrex XW SCP by performing the following steps:

1. On the `System Status` home screen, press `Enter`.
The `Select Device` menu opens.
2. Use the arrow buttons to scroll to the unit, and then press `Enter`.
The `XW MPPT80 xx: Setup` menu appears, where `xx` is the device number.

Viewing Basic and Advanced Settings

The unit’s configuration menus can be viewed in basic and advanced formats. Basic menus contain items you may have to view and adjust on a routine basis. Advanced menus contain items intended for service personnel and one-time setup, such as auxiliary output and custom battery configuration.

To display the `Advanced Settings` menu item instead of the `Basic Settings` menu item, perform the following special keypress:

- ◆ From the `Setup` menu, press the `Enter`, up arrow, and down arrow buttons simultaneously.



On the `Setup` menu, `Basic Settings` disappears from the bottom of the list, and `Advanced Settings` appears at the top of the list.

After configuring the unit, help prevent unintended advanced configuration by using the combined keypress again to hide the advanced menu items.

Modifying Configurable Settings

Configurable settings are identified by square brackets [] around the values along the right side of the screen.

To select and change a configurable setting:

1. On the desired configuration menu, press the up arrow or down arrow button to highlight the setting you want to change.
2. Press Enter to highlight the current value of the setting.
3. Press the up arrow or the down arrow button to change the value. Hold down the button to scroll through a large range of values quickly.
The previously set value appears with an asterisk (*) beside it.
4. Press Enter to select the value.

Configuring Battery Characteristics and Battery Charging

▲ WARNING

HAZARD OF FIRE AND EXPLOSION

Battery charging settings must be configured by qualified personnel in accordance with the battery manufacturer's recommended charging instructions.

Failure to follow these instructions can result in death or serious injury.

CAUTION

RISK OF EQUIPMENT DAMAGE

The unit is incapable of determining battery type and cannot warn against or disallow incorrect settings. The settings for bulk, absorption, float, and equalization charge must be checked carefully against the battery specifications. Incorrect settings can damage the battery or shorten battery life.

Failure to follow these instructions can result in equipment damage.

From various menus in the Xantrex XW SCP you can:

- Enable battery equalization.
- Configure your battery type, voltage, and amp-hour capacity.
- Configure a custom battery type by adjusting settings for each battery charge stage and fine-tuning temperature-compensated charging.
- Monitor battery temperature.

Table 2-1 describes the settings available for the unit's battery configuration.

Table 2-1 Battery Configuration Settings

| Xantrex XW SCP Device Menu Item | Setting | Values | Default | Description |
|-----------------------------------------------------------|--------------|---------------------------------|-----------|-----------------------------------------------------------------------------------------------------------------------------------------------------------------------------------------------------------------------------------------------------------------------------------------------------------------------------------------------------------------------------------------|
| Setup | Equalize | Disabled Enabled | Disabled | Enables or disables battery equalization. If the battery type is set to GEL or AGM, this setting is not displayed. |
| Advanced Settings > Multi Unit Config > Connections | DC Conn | BattBank1...Batt Bankx | BattBank1 | Sets the battery bank connected to the unit. This is important for networked installations, where multiple devices must coordinate their activity around common DC connections. |
| Advanced Settings > Charger Settings | Batt Voltage | 24V 48V | 48V | Sets your nominal battery voltage. Select the nominal voltage level that matches your system's battery voltage. Changing the battery voltage will reset <code>Trigger Level</code> and <code>Clear Level</code> to their default values for the auxiliary output if <code>Trig Src</code> is set to <code>LowBattV</code> or <code>HighBattV</code> (see Table 2-4 on page 2-8). |
| Advanced Settings > Charger Settings | Batt Type | Flooded GEL AGM Custom | Flooded | Sets your battery type. Selecting <code>Custom</code> allows you to adjust equalize, bulk, absorption, and float voltage settings. Battery temperature compensation can also be adjusted on the <code>Custom Battery</code> menu. The <code>Custom</code> option is available only when advanced menus are displayed. |

Table 2-1 Battery Configuration Settings

| Xantrex XW SCP Device Menu Item | Setting | Values | Default | Description |
|--------------------------------------------|----------------------|------------------------------------|----------------|---------------------------------------------------------------------------------------------------------------------------------------------------------------------------------------------------------------------------------------------------------------------------------------------------|
| Advanced Settings > Charger Settings | Batt Capacity | 0–10000Ah | 440Ah | Sets the amp-hour capacity of your battery bank. Setting <code>Batt Capacity</code> to 0 disables the exit current threshold mechanism used to transition from absorption to float. As a result, the unit will transition to float once the <code>Max Absorption</code> timer has elapsed. |
| Advanced Settings > Charger Settings | Max Chg Rate | 1–100% | 100% | Sets the charging current limit. |
| Advanced Settings > Charger Settings | ReCharge Volts | 24V: 20.0–27.0V 48V: 40.0–54.0V | 25.0V 50.0V | Sets the voltage at which the charger transitions from float or no float back to bulk or from absorption back to bulk. |
| Advanced Settings > Charger Settings | Absorb Time | 1–480min | 180min | Sets the maximum time spent in the absorption stage. |
| Setup | Force Chg | Bulk Float No Float | Bulk | Manually advances the charge stage to bulk, float, or no float. |
| Advanced Settings > Charger Settings | Default Batt Temp | Cold Warm Hot | Warm | Sets the default battery temperature for compensation when the BTS is not connected. <code>Cold</code> is suitable for temperatures of around 10 °C (50 °F), <code>Warm</code> for 25 °C (77 °F), and <code>Hot</code> for 40 °C (104 °F). This screen appears only when a BTS is not connected. |
| Setup > Meters | Batt Temp | -40–65 C | n/a | Shows the battery temperature (in Celsius) detected by the BTS. This screen appears only when a BTS is connected. |
| Advanced Settings > Charger Settings | Charge Cycle | 3Stage 2StgNoFloat | 3Stage | Sets the charging cycle (or algorithm): three-stage (bulk, absorption, float) or two-stage (bulk, absorption, no float). |

Setting a Custom Battery Type

The `Custom Settings` menu item allows you to adjust charging and equalization voltage for batteries whose specifications fall outside of the default settings for the battery types that the unit offers.

You can also adjust the temperature compensation constant for the `Battery Temperature Sensor` from the `Custom Settings` menu item.

Important:

- Setting the battery type to `Custom` is possible only when the `Advanced Settings` menu item is displayed.
 - The `Custom Battery` menu is displayed only when the battery type is set to `Custom`.
 - All settings for configuring a custom battery type are based on the default settings for a flooded battery type.
-

The following table describes the available custom battery settings. To access the menu, go to `Advanced Settings > Charger Settings > Custom Settings`.

Table 2-2 Custom Battery Settings

| Setting | Values | Default | Description |
|----------------|-----------------------------------------|-------------------|-----------------------------------------------------------------------------------------------------------------------------------------------------------------------------------------------------------------------------------------------------|
| Eq1z Support | Enabled, Disabled | Enabled | Enables or disables equalization for the custom battery. |
| Eq1z Voltage | 24V: 27.0–32.0V 48V: 54.0–64.0V | 32.0V 64.0V | Sets the equalization voltage (consult your battery manufacturer for equalization voltage setting). This screen is hidden if <code>Eq1z Support</code> is disabled. |
| Bulk Voltage | 24V: 20.0–32.0V 48V: 40.0–64.0V | 28.8V 57.6V | Sets the bulk voltage for a custom battery. |
| Absorb Voltage | 24V: 20.0–32.0V 48V: 40.0–64.0V | 28.8V 57.6V | Sets the absorption voltage for a custom battery. |
| Float Voltage | 24V: 20.0–32.0V 48V: 40.0–64.0V | 27.0V 54.0V | Sets the float voltage for a custom battery. |
| BattTempComp | 24V: -90–0mV/degC 48V: -180–0mV/degC | -54mV -108mV/C | Sets the battery temperature compensation for a custom battery. This setting is the reference that the BTS uses to adjust the charging voltage when the temperature falls above or below 25 °C. See “Battery Temperature Compensation” on page 2–7. |

See “Default Battery Charging Settings” on page A–4 for default settings for standard battery types.

Battery Temperature Compensation

When battery charging voltages are compensated based on temperature, the charge voltage will vary depending on the temperature around the batteries. Temperature compensation can be accomplished automatically by using a BTS. The BTS attaches directly to the side of one of the batteries in the bank and provides precise battery temperature information. See “Installing the Battery Temperature Sensor” in the Xantrex XW MPPT 80 600 Installation Guide for detailed instructions on how and where to install the BTS.

If a BTS is installed, the charge controlling process is automatically adjusted for the battery temperature. The unit uses the following coefficients to adjust the charging voltage¹:

- **Flooded Lead-Acid and Gel-Type Batteries (48 V nominal):**
-108 mV per degree Celsius
- **Absorbed Glass Mat (AGM)-Type Batteries (48 V nominal):**
-84 mV per degree Celsius

If using a BTS, when the battery temperature drops below 25 °C (77 °F), the regulation voltage setting automatically increases. When the temperature rises above 25 °C (77 °F) the regulation battery voltage setting automatically decreases. The temperature range where compensation is applied is between 0 °C and 50 °C. Outside of this temperature range, the compensation value is clamped at the corresponding value for either 0 °C or 50 °C.

If a BTS is not installed, configure the unit to use one of three temperature compensated charge settings:

- Cold: 10 °C (50 °F)
- Warm: 25 °C (77 °F)
- Hot: 40 °C (104 °F)

If significant seasonal variations are common in your area, change the settings multiple times during the year for optimal battery charging.

Configuring Peak Power Tracking

You can disable automatic maximum power point tracking and configure the reference voltage level from which the unit operates. Configuring the reference voltage is not required for normal operation, but it can be useful for testing purposes.

¹.For 24 V battery systems, divide these coefficients by two.

Table 2-3 Peak Power Tracking Settings

| Xantrex XW SCP Device Menu Item | Setting | Values | Default | Description |
|-----------------------------------------------------|----------------|---------------------|-------------|------------------------------------------------------------------------------------------------------------------------------------------------------------------------------------------------------------------|
| Advanced Settings > Input Settings | MPPT AutoTrack | Disabled Enabled | Enabled | Enables or disables MPPT. |
| Advanced Settings > Input Settings | MPPT Ref Volts | 195–600V | N/A | When tracking is set to <i>Disabled</i> , you can select the reference voltage that the unit operates from. When tracking is set to <i>Enabled</i> , the reference voltage updates to reflect tracking activity. |
| Advanced Settings > Multi Unit Config > Connections | PV In | SolarArray 1–16 | SolarArray1 | Sets the input connection for the unit. |

Configuring the Auxiliary Output

Use the *Aux Settings* menu item to enable and configure the auxiliary output. You can use the auxiliary output to operate a relay, indicator light, vent fan, alarm, or any other required function. See “Auxiliary Output Functions” on page 1–8. For configurable trigger sources, you can define trigger level, trigger delay, clear level, and clear delay settings. Non-configurable trigger sources include errors, warnings, and faults.

| |
|------------------------------------------------------------------------------------------------------------------------------------------------------------------------------------------------------------------------------------------------------------------------------------------------------------------------------------------------------------|
| ⚠ WARNING |
| <p>HAZARD OF FIRE</p> <p>The auxiliary NO and NC dry contacts are rated up to 60 VDC and up to 8 A. Do not expose the auxiliary contacts to voltages or currents higher than this rating. Provide external over-current protection rated 8 A maximum.</p> <p>Failure to follow these instructions can result in death or serious injury.</p> |

To display the *Aux* menu auxiliary settings, select *Advanced Settings > Aux Settings*.

Table 2-4 Aux Menu Settings

| Setting | Values | Default | Description |
|------------|------------------------------------|-----------|----------------------------------------------------------------------------------------------------------------------------------------------------------------------------------------------------------------------------------------------------------------------------------|
| Manual Aux | ManualOff ManualOn Automatic | ManualOff | Sets the operating mode for the auxiliary output. When set to <i>Automatic</i> , the auxiliary output will operate according to the selected trigger source. You can toggle the auxiliary relay between NC and NO at any time by selecting <i>ManualOn</i> or <i>ManualOff</i> . |

Table 2-4 Aux Menu Settings

| Setting | Values | Default | Description |
|-----------------------------------------------------------------------------------------------------------------------------|---------------------------------------------------------------------------------------------------------------------------------------------------------------------------------------------------------------------------------------------------------------------------------------------------------------------------------------------------------------------------------------------------------------------------------------------------------------------------------------------------------------------------------------------------------------|----------|--------------------------------------------------------------------------------------------------------------------------------------------------------------------------------------------------------------------------------------------------------------------------------------------------------------------------------------------------------------------------------------------------------------------------------------------------------------------------------------------------------------------------------------------------------------------------------------------------------------------------------------------------------------------------------------------------------------------|
| Note: The remaining settings in this table are only visible when <code>Manual Aux</code> is set to <code>Automatic</code> . | | | |
| Trig Src | <p>Configurable: LowBattV HighBattV LowArrayV HighArrayV LowBattTemp HighBattTemp HighHsTemp</p> <p>Not configurable: Fault SetupFlt GroundFlt InputOVFlt InputOVErr InputOVWrn OutputOVErr OutputOVWrn OutputOCErr BattOTErr BattOTWrn BattUTWrn HsOTErr HsOTWrn AmbOTErr AmbOTWrn CapOTErr FanErr FanFlt OutputUVErr OutputUVWrn InputOCErr OutputOCFlt NetPSFlt SetupErr</p> | LowBattV | <p>Sets the desired condition to activate the auxiliary output. Changing <code>Trig Src</code> while the auxiliary output is already in the triggered state resets the auxiliary output.</p> <p>If <code>Trig Src</code> is set to <code>LowBattV</code> or <code>HighBattV</code>, then changing the battery voltage (see Table 2-1 on page 2-4) will reset <code>Trigger Level</code> and <code>Clear Level</code> to their default values.</p> <p>For a description of these non-configurable faults, errors, and warnings that you can set for <code>Trig Src</code>, see Table 3-4, “Fault Messages” on page 3-6, Table 3-5, “Error Messages” on page 3-7, and Table 3-6, “Warning Messages” on page 3-9.</p> |

Table 2-4 Aux Menu Settings

| Setting | Values | Default | Description |
|---------------|-------------------------------------------|---------|--------------------------------------------------------------------------------------------------------------------------------------------------------------------------------------------------------------------------------------------------------------------------------------------------------------------------------------------------------------------------------------------------------------------------------------------------------------------------------------------------------|
| Trigger Level | Depends on Trigger Source (see Table 2-5) | | <p>Sets the battery or array voltage to activate the auxiliary output. If the selected trigger source is <code>HighBattTemp</code>, <code>LowBattTemp</code>, or <code>HighHsTemp</code>, this screen displays <code>Trigger Temperature Level</code> in degrees Celsius. Changing <code>Trigger Level</code> while the auxiliary output is already in the triggered state resets the auxiliary output.</p> <p>This setting is hidden if the trigger source is set to an error, warning, or fault.</p> |
| Trigger Delay | 0–600s | 1s | <p>Sets how long, in seconds, the selected trigger source must be active before the auxiliary output activates. This can avoid unnecessary triggering by momentary loads.</p> <p>This setting is hidden if the trigger source is set to an error, warning, or fault.</p> |
| Clear Level | Depends on Trigger Source (see Table 2-5) | | <p>Sets the battery or array voltage to turn off the auxiliary output. If the selected trigger source is <code>HighBattTemp</code>, <code>LowBattTemp</code>, or <code>HighHsTemp</code>, this screen displays <code>Clear Temperature Level</code> in degrees Celsius.</p> <p>This setting is hidden if the trigger source is set to an error, warning, or fault.</p> |
| Clear Delay | 0–600s | 1s | <p>Sets how long, in seconds, the trigger condition must remain inactive before the auxiliary output turns off.</p> <p>This setting is hidden if the trigger source is set to an error, warning, or fault.</p> |

Important: If the selected trigger source is `LowBattV` or `HighBattV`, changing the `Batt Voltage` setting will reset the `Trigger Level` and `Clear Level` settings to their default values.

Trigger Source Descriptions

Configurable trigger sources are described below. The text in parentheses indicates how the trigger source appears on the Xantrex XW SCP. The remaining trigger sources are errors, warnings, and faults that are not configurable. See their descriptions in Table 3-6, “Warning Messages” on page 3–9.

Low battery voltage (LowBattV) Activates the auxiliary output when the battery voltage falls below the trigger setting for the trigger delay time. Deactivates the auxiliary output when the battery voltage rises above the clear setting for the clear delay time. Use this setting if you want the auxiliary output to control a relay to disconnect loads from a battery that is nearly discharged, or to activate a low-battery-voltage alarm such as a buzzer or light.

High battery voltage (HighBattV) Activates the auxiliary output when the battery voltage rises above the trigger setting for the trigger delay time. Deactivates the auxiliary output when the battery voltage falls below the clear setting for the clear delay time. This setting is useful for:

- Installations that have another external charging source such as a wind generator or hydro generator connected directly to the batteries. The unit's auxiliary output can control a relay to disconnect the external charging source from the battery when the battery is close to being overcharged or control a relay to turn on a diversion load.
- Activating a high-battery-voltage alarm such as a buzzer or light.
- Activating a vent fan to disperse hydrogen from the battery compartment when the batteries reach their gassing voltage.

Low array voltage (LowArrayV) Activates the auxiliary output when the PV array voltage falls below the trigger setting for the trigger delay time. Deactivates the auxiliary output when the PV array voltage rises above the clear setting for the clear delay time.

High array voltage (HighArrayV) Activates the auxiliary output when the PV array voltage rises above the trigger setting for the trigger delay time. Deactivates the auxiliary output when the PV array voltage falls below the clear setting for the clear delay time. Use this setting if you want the auxiliary output to control a series latching relay to disconnect the PV array from the unit or trigger an alarm when the PV array voltage exceeds the trigger setting (the unit's maximum operating voltage is 550 VDC).

Low battery temperature (LowBattTemp) Activates the auxiliary output when the battery temperature falls below the trigger setting for the trigger delay time. Deactivates the auxiliary output when the battery temperature rises above the clear setting for the clear delay time. Battery temperature is measured with a Battery Temperature Sensor. Do not use this setting if a Battery Temperature Sensor is not installed. With this setting, the auxiliary output can turn on an indicator alarm if the batteries are too cold. A battery with frozen electrolyte will not accept a charge.

High battery temperature (HighBattTemp) Activates the auxiliary output when the battery temperature rises above the trigger setting for the trigger delay time. Deactivates the auxiliary output when the battery temperature falls below the clear setting for the clear delay time. Battery temperature is measured with a Battery Temperature Sensor. Do not use this setting if a Battery Temperature Sensor is not installed. With this setting, the auxiliary output can turn on a fan to cool the battery compartment.

High heat sink temperature (HighHsTemp) Activates the auxiliary output when the unit's heat sink temperature rises above the trigger setting for the trigger delay time. Deactivates the auxiliary output when the heat sink temperature falls below the clear setting for the clear delay time. This setting can be used to trigger an alarm.

Fault (Fault) Activates the auxiliary output when any error, warning, or fault occurs. This trigger source is not configurable.

Trigger Source Configurable Ranges

This table contains the available configuration ranges and default settings for configurable trigger sources. The units vary according to the trigger source selected. If the selected trigger source is based on a battery voltage, the range also varies according to the nominal battery voltage of your system.

Important: Changing the trigger level resets the auxiliary output. If an auxiliary output trigger is active, changing the trigger level will clear the trigger.

Table 2-5 Trigger Source Configuration Ranges

| Trigger Source | Range | Default Trigger | Default Clear |
|--------------------------------------------|--------------|-----------------|---------------|
| Low battery voltage (LowBattV) | 24V: 18–26V | 22V | 24V |
| | 48V: 36–52V | 44V | 48V |
| High battery voltage (HighBattV) | 24V: 24–32V | 28V | 26V |
| | 48V: 48–64V | 56V | 52V |
| Low array voltage (LowArrayV) | 10–600V | 190V | 195V |
| High array voltage (HighArrayV) | 190–600V | 575V | 500V |
| Low battery temperature (LowBattTemp) | -20.0–10.0°C | -10.0°C | -5.0°C |
| High battery temperature (HighBattTemp) | 30.0–60.0°C | 45.0°C | 40.0°C |
| High heat sink temperature (HighHsTemp) | -20–95°C | 90°C | 85°C |

Configuring Device Settings

From various menus, you can change the operating mode of the unit and view the unit's device number. Both these activities may be necessary when performing service or diagnostics and when adding another Xantrex Xanbus-enabled device to the system.

Table 2-6 Device Settings

| Xantrex XW SCP Menu Item | Setting | Values | Default | Description |
|----------------------------------------------------------|-----------------------|----------------------|----------------|--------------------------------------------------------------------------------------------------------------------------------------------------------------------------------------------------------------------------------------------|
| Setup | Mode | Operating Standby | Operating | Operating is the normal mode for the unit. Standby disables the unit so that it cannot charge. The unit still draws some power from the battery to operate. |
| Advanced Settings > Multi Unit Config | Dev Number | 00 to 31 | 00 | Displays the device number for the unit. This number is set when the unit is commissioned and uniquely identifies devices of the same type (charge controllers, inverter/chargers, control panels, and so on) in a networked installation. |
| Select Device > System Settings > View Device Info | F/W Rev. 1.00.00 BN 5 | N/A | N/A | Firmware version and firmware build number. |

| |
|----------------------------------------------------------------------------------------------------------------------------------------------------------------------------------------------------------------------------------------------------------------------------------|
| ⚠ WARNING |
| <p>HAZARD OF FIRE AND EXPLOSION</p> <p>Do not use the <code>Copy from</code> command to copy settings unless the battery banks are identical – same size, type, and so on.</p> <p>Failure to follow these instructions will result in death or serious injury.</p> |

| Xantrex XW SCP Menu Item | Setting | Values | Default | Description |
|-----------------------------|-----------|-------------------------------|---------|-----------------------------------------------------------------------------------------------------------------------------------------------------------------------------------------------------------------------------------------------------------------------------------------------------------------------------------------------------|
| Advanced Settings | Copy from | All available device numbers. | 01 | <p>Enables one-step configuration of a new unit in a multi-unit installation. Select the device number of the unit from which you want to copy the setup. This screen is hidden when no compatible devices are found.</p> <p>The <code>Copy from</code> command copies all charger settings and custom battery settings from the selected unit.</p> |

Important: The `Copy from` command will not give you any indication that it has completed its task. To check that the charger settings have been copied properly, view some of the settings you originally configured.

Settings that are copied from one unit to another are:

- Batt Type
- Batt Capacity
- Max Chg Rate
- Charge Cycle
- ReCharge Volts
- Absorb Time
- Default Batt Temp
- Batt Voltage
- DC Conn
- Custom battery settings (if Custom battery type selected) including Eqlz Support, Eqlz Voltage, Bulk Voltage, Absorb Voltage, Float Voltage, and BattTempComp.

Reducing Tare Loss

By default, the unit is configured to reduce tare losses at night by shutting off the auxiliary power supply. To further reduce power consumption at night, you can configure the unit to also shut off the network (Xantrex Xanbus) power supply. You can change these settings using the **Adv Features** menu item provided you are using a Xantrex XW SCP with firmware version 1.03 or newer.

To display the tare loss settings, select **Advanced Settings > Adv Features**.

Table 2-7 Tare Loss Settings^a

| Setting | Values | Default | Description |
|-----------------|---------------------|----------|-----------------------------------------------------------------------------------------------------------------------------------------------------------------------------------------------------------------------------------------------------------------------------------------------------------------------------------------------------------------------------------------------------------------------------------------------------|
| NetPS Night Dis | Enabled Disabled | Disabled | Enables or disables the network power supply (Xantrex Xanbus) nighttime disconnect. If your system does not require Xantrex Xanbus communication during the night, then set it to Enabled to reduce power consumption. The power supply will automatically turn off two hours after sunset, and then turn on again at sunrise. If your system requires Xantrex Xanbus communication during the night, then leave it set to Disabled . |
| Lo Pwr at Night | Enabled Disabled | Enabled | Enables or disables the auxiliary power supply nighttime disconnect. Leaving the setting as Enabled reduces tare losses during the night. See “Electrical Specifications” on page A-2 for exact specifications. |

a.Xantrex XW SCP with firmware version 1.03 or newer only.

Resetting to Factory Defaults

From the **Advanced Settings** menu item, you can restore factory default settings.

Table 2-8 Resetting to Factory Defaults Setting

| Setting | Values | Default | Description |
|------------------|--------|---------|--------------------------------------------------------------------------------------------------------------------------------------------------------------------------|
| Restore Defaults | N/A | N/A | Returns configurable settings to factory defaults. You will be prompted with a warning asking you to confirm that you want to restore defaults. Press Enter to continue. |

The following settings are reset:

- configurable battery/charger settings
- configurable auxiliary output settings
- configurable input settings

3

Operation

Chapter 3 contains information about operating the Xantrex XW MPPT 80 600.

| For Information on: | See: |
|------------------------------------------------------------|-------------|
| "Viewing Status Information on the Xantrex XW MPPT 80 600" | page 3-3 |
| "Viewing Status on the Xantrex XW System Control Panel" | page 3-3 |
| "Viewing Active Faults, Errors, and Warnings" | page 3-4 |
| "Viewing Fault, Error, and Warning Logs" | page 3-11 |
| "Viewing Harvest Logs" | page 3-11 |
| "Equalizing Batteries" | page 3-12 |

Viewing Status Information on the Xantrex XW MPPT 80 600

The unit has three LEDs for displaying basic operating information. The LEDs are On/Charging (green), Error/Warning (red), and Equalize (orange).

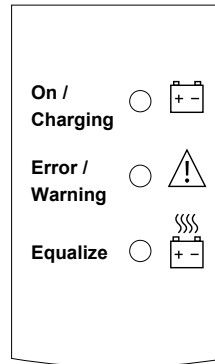

Figure 3-1 Xantrex XW MPPT 80 600 Status LEDs

Table 3-1 Xantrex XW MPPT 80 600 Status LEDs

| LED | Description |
|----------------------------|--------------------------------------------------------------------------------------------------------------------------------------------------------------------------------------------------------------------------------------------------------------------------------------------------------------------------------------------------------------------------------------------------------------------------|
| On/ Charging (Green) | <ul style="list-style-type: none"> • Solid when the unit is connected to a battery, providing visual feedback that the unit is powered on. • Flashing at a variable rate when the unit is charging a battery. Slow flashing indicates a low charge rate, and fast flashing indicates a faster charge rate. |
| Error/ Warning (Red) | <ul style="list-style-type: none"> • Solid when the unit has detected an error or fault condition. • Flashing at a constant rate when the unit has detected a warning condition. <p>View the error, fault, or warning and its description on the Xantrex XW SCP.</p> |
| Equalize (Orange) | <ul style="list-style-type: none"> • Solid when an equalize charge has been enabled via the Xantrex XW SCP but has not yet started (the unit must complete a full bulk and absorption cycle before it can begin the equalize cycle). • Flashing at a constant rate when the unit is performing the equalize charge to the batteries. After the equalize charge has completed, the LED goes dark. |

Viewing Status on the Xantrex XW System Control Panel

Use the Xantrex XW System Control Panel (Xantrex XW SCP) to configure and view system information and operating status. See Appendix B, “Xantrex XW System Control Panel Menus” for an overview of the Xantrex XW SCP, or view the entire Xantrex XW SCP Owner’s Guide (Document Part Number 975-0298-01-01) at www.schneider-electric.com. The unit also has three LEDs for displaying basic status regarding charging, equalization, and fault, error, and warning conditions.

- When in Charge Control mode the Xantrex XW SCP displays parameters such as PV voltage, battery voltage, and charge current on the XW MPPT80 Home screen.
- When a fault or error condition exists, the Xantrex XW SCP Fault/Warning light is solid, and the Xantrex XW SCP shows `Fault Active` on the XW MPPT80 Home screen.
- When a warning condition exists, the Xantrex XW SCP Fault/Warning light is flashing, and the Xantrex XW SCP shows `Warning Active` on the XW MPPT80 Home screen.

Normal Operation

From the XW MPPT80 Setup screen, select `Meters` to view normal operation information. This information is refreshed once per second.

Table 3-2 Normal Operation Information (Meters Screen)

| Display | Description |
|---------------------------|---------------------------------------------------------------------------------------------------------------------|
| PV In Power | Measured input power. |
| PV In | Measured input voltage and current. |
| DC Out Power | Power being produced by the unit now. |
| DC Out | Measured output voltage and output current. |
| Time in Float 00:00:00 | Elapsed time that the unit has been in float in hh:mm:ss format. |
| Today | Accumulated amp hours and kilowatt hours produced today by the unit. |
| Life | Lifetime accumulated amp hours and kilowatt hours produced by the unit. |
| Batt Temp | Battery temperature detected by the BTS. If a BTS is not connected, no value is shown. |
| State | Charge stage. See Table 3-3 on page 3–4. |
| Aux | Auxiliary output state. See Table 2-4 on page 2–8. |
| Thermal Derating | Indicates whether the unit is derating output power due to high operating temperatures. See Figure A-4 on page A–5. |

Charge Stages

The charge stages displayed on the Xantrex XW SCP are described in Table 3-3. The charge states are displayed under `State` on the `Meters` screen.

Table 3-3 Charge Stages

| Text | Description |
|--------------|----------------------------------------------------------------------------------------------------------------------------------------------------------------------------------------------------------------------------------------------------------------------------------------------------------------------------------------------------------------------------------------------------------------------------------------------------------------------|
| Bulk | Batteries are charging at the maximum current available from the unit. If the unit shuts down because of low input PV voltage, then charging will resume in bulk mode. This means the unit starts in bulk at the beginning of every day, regardless of the battery voltage. If the batteries are fully charged, the bulk/absorption cycle finishes after a short period and the unit transitions to float/no float (depending on charge cycle configuration). |
| Absorb | After transitioning from bulk mode, the unit holds the battery voltage at the absorption voltage setting and the charge current gradually declines as the battery capacity is restored. The unit stops absorption charging when one of two conditions are met, as described in “Absorption Stage” on page 1–4. |
| Float | Battery voltage is held at the float voltage setting. When the battery voltage drops below the <code>ReCharge Volts</code> setting for a cumulative period of one minute, a new bulk charge cycle is triggered. |
| No Float | The charger does not output any power during this stage. When the battery voltage drops below the <code>ReCharge Volts</code> setting for a cumulative period of one minute, a new bulk cycle is triggered. |
| Equalize | A deliberate overcharge designed to return each battery cell to optimum condition by reducing sulfation and stratification in the battery. An equalization charge lasts one hour. |
| Not Charging | No charging is occurring because the input power from the PV array has fallen below the minimum PV array operating voltage (as specified in “Electrical Specifications” on page A–2). |

Viewing Active Faults, Errors, and Warnings

When a fault, error, or warning occurs, a message is displayed on the Xantrex XW SCP. You can also view active faults, errors, and warnings from the `System Settings` menu.

Warning messages indicate a problem that could affect normal operation. The unit’s red LED flashes when there is a warning condition. The Xantrex XW SCP Fault/Warning light flashes red, and the warning message is displayed on the Xantrex XW SCP. Normal operation continues until the warning escalates to a fault or error condition.

Fault messages indicate a fault or error condition. The unit’s red LED is solid when there is a fault or error condition. The Xantrex XW SCP Fault/Warning light is solid red, and the fault message is displayed on the Xantrex XW SCP. When a fault or error occurs, MPPT and charging functions may be disabled.

The following faults do not disable normal operation:

- Fan over voltage
- Fan over current
- Fan under voltage
- Fan under current
- Network power supply

Most warnings, errors, and faults clear automatically once the condition that caused them goes away. However, the following faults must be cleared manually:

- Auxiliary power supply
- Ground fault protection
- Input over voltage
- Output over current
- Fan over voltage
- Fan over current
- Fan under voltage
- Fan under current
- Network power supply

To view the complete list of active faults, errors, and warnings:

1. On the `Select Device` menu, scroll to `System Settings`, and then press Enter.
The `System Settings` menu opens.
2. Scroll to `View Fault List` or `View Warning List`, and then press Enter.
The fault/error or warning menu opens.
3. Press the down button to view additional fault, error, or warning messages. If there are no active faults, errors, or warnings, no messages are displayed.

To manually clear a fault, error, or warning:

1. On the `Select Device` menu, scroll to `System Settings`, and then press Enter.
The `System Settings` menu opens.
2. Scroll to `Clear All Flts/Wrns`, and then press Enter.¹

1. Additional steps are required for a ground fault. See "GroundFlt1" in Table 3-4.

Faults

Table 3-4 lists all possible faults. Faults are conditions that indicate that the unit might have incurred permanent damage or that user intervention is required before the unit will operate again. If one of these faults occur, the unit might also need to be serviced before it can be fully operational again.

Table 3-4 Fault Messages

| Display Text (Description) | Fault ID | Definition |
|------------------------------------------------|----------|-----------------------------------------------------------------------------------------------------------------------------------------------------------------------------------------------------------------------------------------------------------------------------------------------------------------------------------------------------|
| AuxPSFlt (Auxiliary power supply fault) | F54 | Appears when there are more than two auxiliary power supply errors (F26) within one minute. Damage to the unit is possible, so the fault will not clear until an operator clears it manually using the Xantrex XW SCP. |
| GroundFlt1 (Ground fault, type 1) | F56 | Appears when a PV ground fault has been detected. The ground fault message clears after system power is removed, the ground fault is corrected, the GFP fuse is replaced by qualified personnel (negative or positive grounded systems only), and system power is restored. See the Xantrex XW MPPT 80 600 Installation Guide for more information. |
| GroundFlt2 (Ground fault, type 2) | F83 | Appears when there is a problem with the hardware circuitry used to detect ground faults. Contact customer service for assistance. |
| InputOVFlt (Input over voltage fault) | F74 | Appears immediately when the input voltage exceeds 600 VDC. Damage to the unit is possible, so the fault will not clear until an operator clears it manually using the Xantrex XW SCP. |
| FanOVFlt (Fan over voltage fault) | F75 | Appears immediately when fan voltage rises above 13.8 V. The fan will cease operating, but the unit will continue operating though it will probably experience power derating. The fault will not clear until an operator clears it manually using the Xantrex XW SCP. |
| OutputOCFlt (Output over current fault) | F78 | Appears when there are three fast output (F71) or slow output (F73) over current errors within 30 seconds. The fault will not clear until an operator clears it manually using the Xantrex XW SCP. |
| FanOCFlt (Fan over current fault) | F79 | Appears when there are more than two Fan Errors in a 30 second period. The fan will cease operating, but the unit will continue operating though it will probably experience power derating. The fault will clear itself when the operator toggles power to the unit. |
| FanUVFlt (Fan under voltage fault) | F80 | Appears immediately when fan voltage falls below 3.5 V. The fan will cease operating, but the unit will continue operating though it will probably experience power derating. The fault will not clear until an operator clears it manually using the Xantrex XW SCP. |

Table 3-4 Fault Messages

| Display Text (Description) | Fault ID | Definition |
|----------------------------------------------|----------|---------------------------------------------------------------------------------------------------------------------------------------------------------------------------------------------------------------------------------------------------------------------------------------------------------------------------------------------------------------------------------------------------------------------------------------------------------------------------------------------------------------------------------------------------------------------|
| FanUCFlt (Fan under current fault) | F81 | Appears when fan current falls below 0.5 A for 100 milliseconds. The fan will cease operating, but the unit will continue operating though it will probably experience power derating. The fault will not clear until an operator clears it manually using the Xantrex XW SCP. |
| NetPSFlt (Network power supply fault) | F82 | Appears when the unit detects either a short circuit or an over load condition on the Xantrex Xanbus Network Power Supply. It also appears if the unit detects an over voltage event on the Xanbus Network Power Supply. The network power supply will be turned off, and loss of Xantrex Xanbus communication is possible. The fault will not clear until an operator clears it manually. The operator might have to power cycle the unit if no other devices are present on the Xantrex Xanbus network to provide network power to run the Xantrex XW SCP. |

Errors

Table 3-5 lists all possible errors. Errors are situations where the unit has stopped itself from operating because of a problem.

Table 3-5 Error Messages

| Display Text (Description) | Error ID | Definition |
|----------------------------------------------------|----------|-----------------------------------------------------------------------------------------------------------------------------------------------------------------------------------------------------------------------------------------------------------------------------------------------------------------------------------------------------------------------------|
| CapOTErr (Capacitor over temperature error) | F2 | Appears when the output capacitor temperature rises above 100 °C (212 °F) for 5 seconds. The error clears itself when the capacitor temperature falls below 90 °C (194 °F) for 30 seconds. This error should not normally occur. If it is triggered multiple times on a unit, the unit must be serviced. |
| BattOTErr (Battery over temperature error) | F4 | Appears when the battery temperature rises above 60 °C (140 °F) for 30 seconds. The error clears itself when the battery temperature falls below 55 °C (131 °F) for 30 seconds. |
| AmbOTErr (Ambient over temperature error) | F5 | Appears when the ambient temperature inside the unit rises above 80 °C (176 °F) for 5 seconds. The error clears itself when the ambient temperature falls below 65 °C (149 °F) for 30 seconds. |
| InputOVerErr (Input over voltage error) | F9 | Appears immediately when the input voltage exceeds the input over voltage shut off value, which is dependent upon temperature measured on the heatsink (Vin High Threshold in Figure 3-2 on page 3–10). The error clears itself when the input voltage falls below the input over voltage restart value (Vin Restart Threshold in Figure 3-2 on page 3–10). |

Table 3-5 Error Messages

| Display Text (Description) | Error ID | Definition |
|----------------------------------------------------------|-----------------|------------------------------------------------------------------------------------------------------------------------------------------------------------------------------------------------------------------------------------------------------------------------------------------------------------------------------------------------|
| OutputUVImmErr (Output under voltage immediate error) | F10 | Appears immediately when the output voltage falls below 15.8 VDC. The error clears itself when the voltage rises above 19.0 VDC for 1 second. |
| OutputUVErr (Output under voltage error) | F11 | 24 V System: Appears within 1 second when the output voltage falls below 18.0 VDC. The error clears itself when the voltage rises above 19.0 VDC for 1 second. 48 V System: Appears within 1 second when the output voltage falls below 36.0 VDC. The error clears itself when the voltage rises above 38.0 VDC for 1 second. |
| AuxPSErr Auxiliary power supply error | F26 | Appears immediately when the auxiliary power supply is not within its expected operating range. The error clears itself after 1 second and the auxiliary power supply will attempt to restart. |
| HsOTErr (Heat sink over temperature error) | F55 | Appears when the heat sink temperature rises above 90 °C (194 °F) for 5 seconds. The error clears itself when the heat sink temperature falls below 80 °C (176 °F) for 30 seconds. |
| SetupErr | F69 | Appears when multiple units connected to the Xantrex Xanbus network have the same device number. The error will clear when the operator changes the device numbers of the duplicate units. The device number can be changed in the Multi Unit Config screen of the Xantrex XW SCP. |
| OutputOVErr (Output over voltage error) | F70 | 24 V System: Appears when the output voltage rises above 33.0 VDC for 1 second. The error clears itself when the voltage falls below 32.0 VDC for 1 second. 48 V System: Appears when the output voltage rises above 65.0 VDC for 1 second. The error clears itself when the voltage falls below 64.0 VDC for 1 second. |
| OutpFastOCErr (Fast output over current error) | F71 | Appears immediately when output current rises above 117.5 ADC. The error clears itself after 5 seconds. If the error is triggered three times in a span of 30 seconds, then it must be cleared manually. |
| OutpSlowOCErr (Slow output over current error) | F73 | Appears when output current rises above 90.0 ADC for 10 milliseconds. The error clears itself after 5 seconds. |
| FanOCErr (Fan over current error) | F76 | Appears when fan current rises above 1.6 A for 20 milliseconds. The error clears itself when fan current falls below 1.0 A for 1 second. |

Table 3-5 Error Messages

| Display Text (Description) | Error ID | Definition |
|----------------------------------------------|----------|--------------------------------------------------------------------------------------------------|
| InputOCErr (Input over current error) | F77 | Appears immediately when PV current rises above 25 ADC. The error clears itself after 5 seconds. |

Warnings

Table 3-6 lists all possible warnings. Warnings indicate that one of the unit's operating parameters is approaching the specified limits for the device.

Table 3-6 Warning Messages

| Display Text (Description) | Warning ID | Definition |
|------------------------------------------------------|------------|----------------------------------------------------------------------------------------------------------------------------------------------------------------------------------------------------------------------------------------------------------------------------------------------------------------------------------------------------------|
| BattOTWrn (Battery over temperature warning) | W4 | Appears when the battery temperature rises above 50 °C (122 °F) for 10 seconds. The warning clears itself when the battery temperature falls below 45 °C (113 °F) for 10 seconds. |
| AmbOTWrn (Ambient over temperature warning) | W5 | Appears when the ambient temperature inside the unit rises above 70 °C (158 °F) for 10 seconds. The warning clears itself when the ambient temperature falls below 65 °C (149 °F) for 10 seconds. |
| BattUTWrn (Battery under temperature warning) | W9 | Appears when the battery temperature falls below -20 °C (-4 °F) for 10 seconds. The warning clears itself when the battery temperature rises above -10 °C (14 °F) for 10 seconds. |
| Input over voltage warning (InputOVWrn) | W11 | This warning follows the same curve as the Input over voltage error, but it triggers 10 V lower. The warning clears itself when the voltage falls to the input over voltage restart value – 15 V for 1 second. The input over voltage restart value is Vin Restart Threshold in Figure 3-2 on page 3-10. |
| OutputUVWrn (Output under voltage warning) | W12 | 24 V System: Appears when the output voltage falls below 20.0 VDC for 10 seconds. The warning clears itself when the voltage rises above 21.0 VDC for 10 seconds. 48 V System: Appears when the output voltage falls below 40.0 VDC for 10 seconds. The warning clears itself when the voltage rises above 42.0 VDC for 10 seconds. |

Table 3-6 Warning Messages

| Display Text (Description) | Warning ID | Definition |
|-----------------------------------------------------|------------|-----------------------------------------------------------------------------------------------------------------------------------------------------------------------------------------------------------------------------------------------------------------------------------------------------------------------------------------------------------------|
| OutputOVWrn (Output over voltage warning) | W34 | <p>24 V System: Appears when the output voltage rises above 31.5 VDC for 10 seconds. The warning clears itself when the voltage falls below 30.5 VDC for 10 seconds.</p> <p>48 V System: Appears when the output voltage rises above 63.0 VDC for 10 seconds. The warning clears itself when the voltage falls below 61.0 VDC for 10 seconds.</p> |
| HsOTWrn (Heat sink over temperature warning) | W35 | Appears when the heat sink temperature rises above 85 °C (185 °F) for 10 seconds. The warning clears itself when the heat sink temperature falls below 80 °C (176 °F) for 10 seconds. |

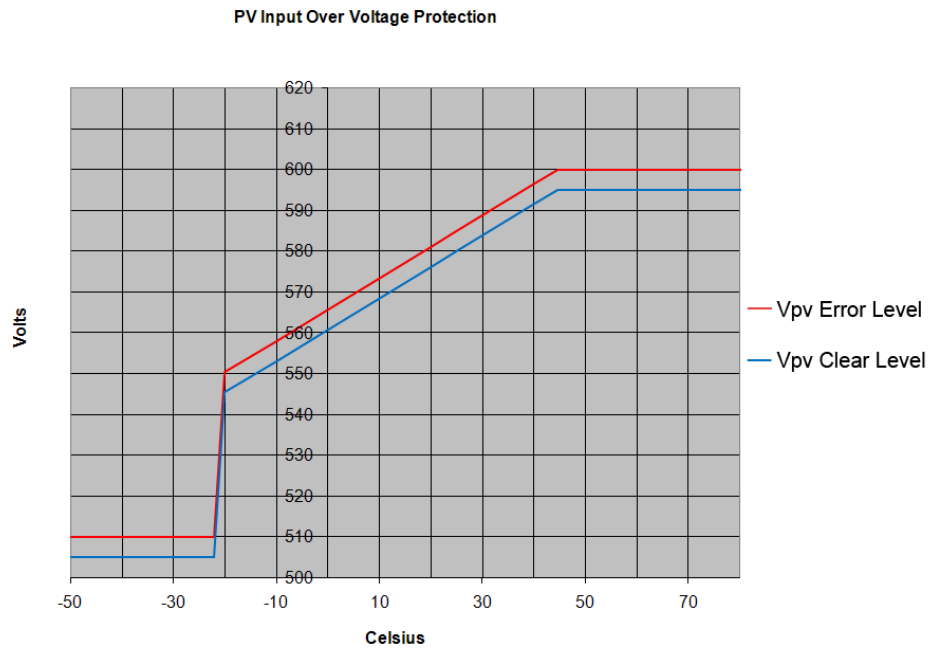

Figure 3-2 Over Voltage Protection

Viewing Fault, Error, and Warning Logs

The Xantrex XW SCP displays fault, error, and warning logs stored on the unit.

Table 3-7 History Menu Items

| Xantrex XW SCP Device Menu | Item | Description |
|-----------------------------|------------------|------------------------------------------|
| Setup > View Device Info | View Fault Log | Displays a log of the faults and errors. |
| Setup > View Device Info | View Warning Log | Displays a log of the warnings. |

Fault and Error Logs

To view the fault and error logs, go to Setup > View Device Info > View Fault Log. Press the down arrow to view all the entries. The faults and errors are listed chronologically, with the most recent fault or error at the top of the list. The fault/error number, fault/error date, and fault/error time are displayed. Press Enter to view details for a particular fault or error, including the name. The twenty most recent faults and errors are stored.

Warning Logs

To view the warning logs, go to Setup > View Device Info > View Warning Log. Press the down arrow to view all the entries. The warnings are listed chronologically, with the most recent warning at the top of the list. The warning number, warning date, and warning time are displayed. Press Enter to view details for a particular warning, including the warning name. The twenty most recent warnings are stored.

Viewing Harvest Logs

The Xantrex XW SCP displays the daily, monthly, and yearly performance logs stored on the unit.

Important: To record monthly and yearly logs, the unit must be connected to a Xantrex Xanbus network real-time clock source. If you require monthly and yearly logs to be created and stored, make sure the unit is attached to the Xantrex Xanbus network with one of the following:

- Xantrex XW Hybrid Inverter/Charger
- Xantrex XW System Control Panel
- Xantrex Gateway

Table 3-8 Harvest Logs Menu Items

| Xantrex XW SCP Device Menu | Item | Description |
|-----------------------------------|--------------|-------------------------------------------------------------------------------------------------------------------------------------------------------------------------------|
| Setup > Harvest Logs | Daily Logs | Displays a log of the unit's amp-hour and kilowatt-hour production for the day. The peak power output and time in float for the day are recorded as well. |
| Setup > Harvest Logs | Monthly Logs | Displays a log of the aggregate total for amp hours and kilowatt hours produced during the month. The peak power output and time in float for the month are recorded as well. |
| Setup > Harvest Logs | Yearly Logs | Displays a log of the aggregate total for amp hours and kilowatt hours produced during the year. The peak power output and time in float for the year are recorded as well. |

Daily Logs

To view the daily logs stored in memory, go to Setup > Harvest Logs. Press Enter from the `Daily Logs` screen. Press the down arrow button to scroll through the daily logs, starting with the current date.

The unit stores up to 62 daily logs. After 62 days, the oldest daily log is overwritten.

Monthly Logs

To view the monthly logs stored in memory, go to Setup > Harvest Logs. Press Enter from the `Monthly Logs` screen. Press the down arrow button to scroll through the monthly logs, starting with the current month.

The unit stores up to 24 monthly logs. After 24 months, the oldest monthly log is overwritten.

Yearly Logs

To view the yearly logs stored in memory, go to Setup > Harvest Logs. Press Enter from the `Yearly Logs` screen. Press the down arrow button to scroll through the yearly logs, starting with the current year.

The unit stores up to 12 yearly logs. After 12 years, the oldest yearly log is overwritten.

Equalizing Batteries

Equalization charging is the process of deliberately charging a battery (or battery bank) at a high voltage for a set period of time. Equalize charging remixes the electrolyte, helps to remove sulfate buildup on the battery plates, and balances the charge of individual cells.

Make sure to read all cautions and warnings regarding equalization charging batteries before allowing an equalization charge to occur.

Important: In a system where more than one device is capable of equalizing batteries (such as a system including multiple units and Xantrex XW Hybrid Inverter/Chargers), there is no system-wide equalization command for all devices. To equalize with multiple devices, each would have to be enabled individually. Alternatively, equalization can be performed using only one device. During the equalization process, one device applies the equalization charge while the other devices continue to operate in synchronized charge mode, typically in float (three-stage charging) or no float (two-stage charging).

⚠ WARNING

HAZARD OF EXPLOSION

Equalization charging generates explosive gases which might escape from the battery. Make sure adequate ventilation is provided. Never leave a battery unattended during equalization. Follow the battery manufacturer's recommended actions for determining the appropriate point at which to stop the equalization process, for example, by monitoring electrolyte specific gravity.

Failure to follow these instructions can result in death or serious injury.

CAUTION

HAZARD OF BATTERY DAMAGE

Never equalize a battery more than necessary. Equalization can damage your batteries if performed too frequently or done improperly. Always check electrolyte level before and after equalization. Fill with distilled water according to the battery manufacturer's recommendation.

The unit enables equalization only when the battery type is set to Flooded. Equalize mode is disabled if you have selected GEL and AGM as the battery type. As a general rule, do not equalize a battery unless there are provisions to add water to it and the manufacturer recommends equalization.

Failure to follow these instructions can result in equipment damage.

CAUTION

HAZARD OF EQUIPMENT DAMAGE

Equalization voltage may be as high as 32 V (for 24 V systems) or 64 V (for 48 V systems) and may damage some types of DC load equipment connected to the battery. Disconnect any loads that are not rated to withstand the applicable equalization voltage.

Failure to follow these instructions can result in equipment damage.

Important: The Xantrex XW Hybrid Inverter/Charger and Xantrex XW Power Distribution Panel will not be damaged by equalization voltage and do not need to be disconnected during equalization

Follow the battery manufacturer's recommendations for equalizing your batteries. As a guide, a heavily used flooded battery may need to be equalized once a month, and a battery in light service may only need to be equalized every two to four months.

The equalization process lasts one hour. When the equalization period has expired, the unit will return to either the float or no float charge stage.

To enable battery equalization:

1. On the Setup menu screen scroll to `Equalize`, and then press Enter.
2. Change the setting to `Enabled`.

The unit goes back to the bulk stage and goes through bulk and absorption before entering the equalization stage. The full charge cycle makes sure the batteries are fully charged before an equalization is attempted.

The unit applies the equalization charge for one hour. You can stop the equalization process manually at any time by changing the setting to `Disabled`.

The one hour equalization timer will continue to run even if there is insufficient power from the PV array to support this charge mode.

To determine when battery equalization is complete:

- ◆ Follow the battery manufacturer's recommendations for equalizing the batteries. These recommendations will include methods such as monitoring the specific gravity (SG) of the electrolyte using a battery hygrometer and stopping the equalization when the SG has stopped increasing.
 - If the recommended point is reached before the automatic one hour equalization timer runs out, then manually stop the equalization by changing the setting to `Disabled`.
 - If the recommended point is not reached after one hour, the unit will automatically exit the equalization stage. You can re-start equalization by following the process above and continue equalizing until the battery manufacturer's recommendation is met.

To manually stop battery equalization:

1. On the Setup Menu, scroll to `Equalize`, and then press Enter.
2. Change the setting to `Disabled`.

Equalization stops, and the unit goes to either the float or no float stage, depending on the charge mode selected.

4

Troubleshooting

Chapter 4 contains information about identifying and resolving possible problems that may arise while using a Xantrex XW MPPT 80 600.

Troubleshooting

Table 4-1 lists possible problems that may arise when using the unit.

Table 4-1 PV Charge Control Problems

| Problem | Possible Cause | Solution |
|----------------------------------------------------------------------------------------------------------------|--------------------------------------------------------------------------------------------------------------------------------------------------------------------------------------------------------------------------------------------------------------------------------------------|------------------------------------------------------------------------------------------------------------------------------------------------------------------------------------------------------------------------------------------------------------------------------------------------------------------------------------------------------------------------------------------------------------------------------------------------------------------------------------------|
| Battery voltage is exceeding bulk and float settings in cold weather and not reaching settings in hot weather. | Battery temperature sensor (BTS) is compensating charging voltages based on battery temperature. | No problem. This is the intended operation. |
| The unit's Error/Warning (red) LED is on or flashing. | An active fault, error, or warning is present on the unit. | See "Viewing Active Faults, Errors, and Warnings" on page 3-4 to determine which alarm is active on the unit. The tables in this section provide detailed information on why various alarms could be occurring on the unit. |
| Battery equalization was enabled but did not occur. | The unit must complete a bulk/absorption cycle before it can initiate an equalization cycle. | See "Equalizing Batteries" on page 3-12 for information on equalization charging. See "Viewing Status Information on the Xantrex XW MPPT 80 600" on page 3-2 for information on determining the status of the equalization cycle. |
| BTS information does not show up on the unit's Meters screen on the Xantrex XW SCP. | The BTS reading is only shown on the Meters screen if the BTS is physically connected to the device you are viewing on the Xantrex XW SCP. All devices share BTS information, but they only report the information to the Xantrex XW SCP if they have the BTS plugged into their BTS port. | Navigate to the Meters screen on the Xantrex XW SCP for the device that has the BTS connected to it. |
| Thermal derating is indicated on the Xantrex XW SCP. | <p>A. The unit is operating in a high ambient temperature environment at high power levels.</p> <p>B. The fans are not working properly.</p> | <p>A. The unit is specified to operate at full output power up to 45 °C. Derating occurs at temperatures above this level.</p> <p>B. Make sure that you have not blocked the ventilation holes at the top and bottom of the unit and that you have provided sufficient clearance for proper ventilation of the unit. Check the active fault list and the historical fault log on the Xantrex XW SCP to see if the unit has registered any faults or errors related to fan operation.</p> |

Table 4-1 PV Charge Control Problems

| Problem | Possible Cause | Solution |
|---------------------------------------------------------------------------------------------------------------------------|------------------------------------------------------------------------------------------------------------------------------------------------------------------------------------------------|----------------------------------------------------------------------------------------------------------------------------------------------------------------------------------------------------------------------------------------------------------------------------------------------------------------------------------------------------------------------|
| The unit's Error/Warning (red) LED is on, and the Xantrex XW SCP indicates an input over voltage error (F9) for the unit. | The PV panels are producing voltage levels that are outside the operating specifications for the unit. This is likely due to the panels experiencing extreme cold temperatures for the region. | This condition will correct itself when the panels warm up and the voltage decreases to within operating specifications. If it occurs regularly, then the installation likely has too many PV panels in series and may need reconfiguration to lower the voltage to the unit. See "Electrical Specifications" on page A-2 for details on the unit's operating range. |
| The unit's On/Charging (green) LED is flashing. | The unit is outputting charge current. | No problem. This is intended operation. See "Viewing Status Information on the Xantrex XW MPPT 80 600" on page 3-2 for LED status information. |
| The Xantrex XW SCP turns off completely after sunset. | The Xantrex XW SCP is powered by the output of the unit, and it has been configured to turn off the Xantrex Xanbus power supply during the night. | See "Reducing Tare Loss" on page 2-15 for more information on disabling certain power supplies at night to reduce night time tare losses. |
| The unit's Error/Warning (red) LED is on, and the Xantrex XW SCP is blank. | The network power supply fault ("F82" on page 3-7) has been triggered and has disrupted power to the Xantrex XW SCP. | Remove power to the unit by opening the PV and battery disconnects long enough for the red and green LEDs to turn off. Restore power by closing the PV and battery disconnects, and then confirm that the Xantrex XW SCP resumes operation. Contact customer service if the problem is not resolved. |

A

Specifications

Appendix A provides the specifications for the Xantrex XW MPPT 80 600.

| For information on: | See: |
|-------------------------------------------|-------------|
| "Electrical Specifications" | page A-2 |
| "Default Battery Charging Settings" | page A-4 |
| "Mechanical Specifications" | page A-5 |
| "Output Power Versus Ambient Temperature" | page A-5 |
| "Optional Accessories" | page A-6 |
| "Regulatory Approvals" | page A-6 |

All specifications are subject to change without notice.

Electrical Specifications

| | |
|----------------------------------------------------|-------------------------------------------------------------------------------------------------------|
| Maximum PV Array Open Circuit Voltage | 600 VDC |
| PV Array Voltage Operating Range | 195 to 550 VDC |
| PV Array Voltage Full Power Range ^a | 230 to 550 VDC |
| Maximum Power Point Tracking Range | 195 to 510 VDC |
| PV Input Start Voltage | 230 VDC |
| PV Input Current Limit | 23 ADC (electronically limited) |
| Maximum Permissible PV Short Circuit Rated Current | 28 ADC @ STC |
| Nominal Battery Voltages | 24 and 48 VDC (Default is 48 V) |
| Battery Voltage Operating Range | 16 to 67 VDC |
| Maximum Charging Current | 80 A |
| Maximum Charging Power | 2560 W (nominal 24 V battery bank) 4800 W (nominal 48 V battery bank) |
| Maximum Power Conversion Efficiency | 94% (nominal 24 V battery bank) 96% (nominal 48 V battery bank) |
| Auxiliary Output | Dry contact switching up to 60 VDC, 30 VAC, 8 A |
| Charger Regulation Method | Three stage (bulk, absorption, float) Two stage (bulk, absorption) |
| Tare Losses ^b | less than 1.0 W (Xantrex Xanbus power supply on) less than 0.5 W (Xantrex Xanbus power supply off) |

a. Full power output below 230 V is not assured. See "Operating Below the PV Array Voltage Full Power Range" on page A-3 for more information.

b. These values are based on the following specifications:

- The battery voltage is 48 V.
- The auxiliary power supply is shut off at night. See "Reducing Tare Loss" on page 2-15 for more information.

MPPT Voltage Range

The unit's Maximum Power Point Tracking (MPPT) algorithm maximizes the output energy of PV arrays as long as the operating voltage is within the MPPT operational window. Make sure that the PV arrays used in the system operate within the MPPT operational window. Effects of array voltages outside of the MPPT operational window are shown below.

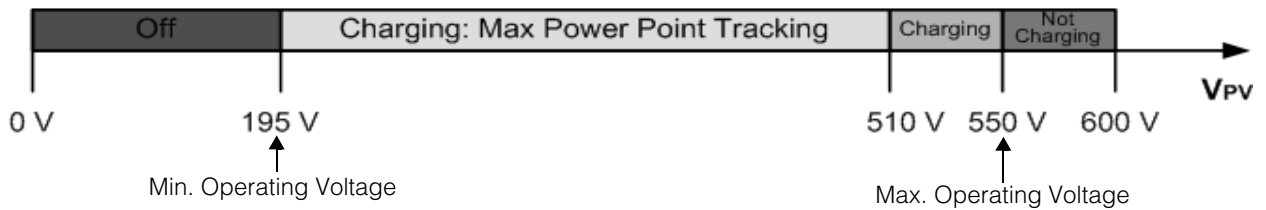

Note:
 Max VOC 600 V
 Input Current limit 23 A
 Output current limit 80 A

Figure A-1 MPPT Operational Window

Operating Below the PV Array Voltage Full Power Range

When the unit is operating on a 48 V battery bank and a PV array where the MPP is below 230 V, full output power is not assured. Figure A-2 and Figure A-3 show the maximum output current and maximum output power that can be produced when the unit is operating below 230 V. Note that the actual amount of current and power that your unit can produce below 230 V will depend on the actual battery voltage, and the amount of solar power available from your panels. Full output current is available on 24 V battery systems across the entire input voltage operating range.

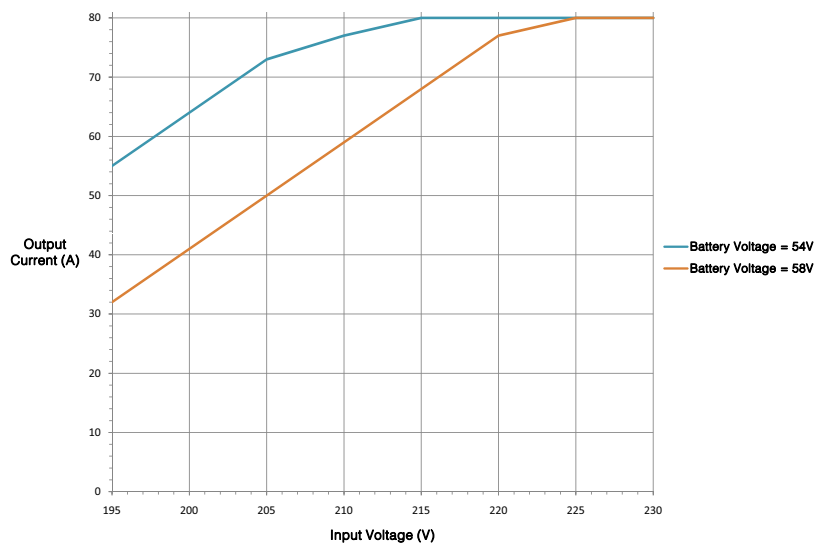

Figure A-2 Maximum Expected Output Current Versus Input Voltage

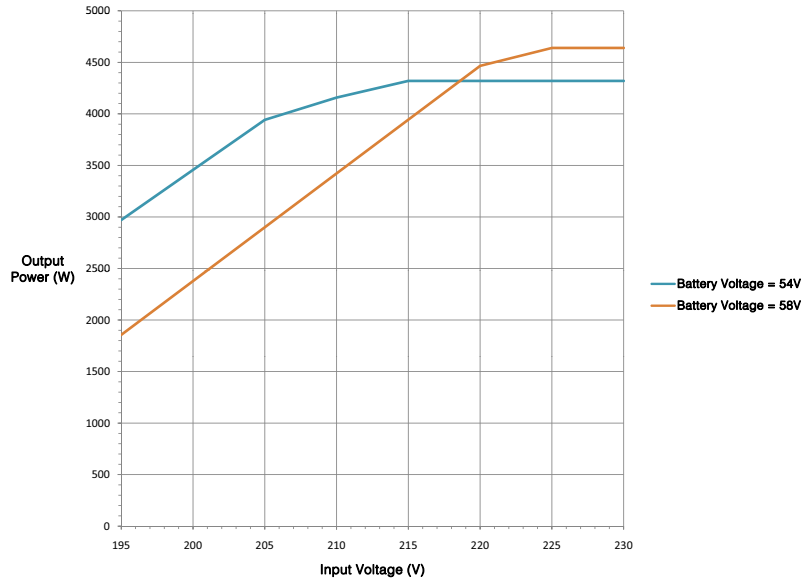

Figure A-3 Maximum Expected Output Power Versus Input Voltage

Default Battery Charging Settings

All settings in the following table are based on a 48 V nominal battery bank. For a 24 V nominal battery bank, divide the voltage values in this table by two.

| Setting | Battery Type | | |
|--------------------|----------------------|-----------|----------|
| | Flooded ^a | Gel | AGM |
| Equalize Voltage | 64.0 V | n/a | n/a |
| ReCharge Voltage | 50.0 V | 50.0 V | 50.0 V |
| Bulk Voltage | 57.6 V | 56.8 V | 57.2 V |
| Absorption Voltage | 57.6 V | 56.8 V | 57.2 V |
| Float Voltage | 54.0 V | 55.2 V | 53.6 V |
| Absorption Time | 360 min | 360 min | 360 min |
| Batt Temp Comp | -108 mV/C | -108 mV/C | -84 mV/C |

a. When Custom is selected for the battery type, the default settings are based on the flooded battery type.

Mechanical Specifications

| | |
|----------------------------------------------------------------|----------------------------------------------------------------------------------------------------------------------------------|
| Enclosure Type | IP20, indoor, ventilated, aluminum sheet metal chassis with 7/8" and 1" (22.22 mm and 27.76 mm) knockouts and aluminum heat sink |
| Maximum and Minimum Wire Size in Conduit | #6 AWG to #14 AWG (13.5 to 2.5 mm ²) |
| Maximum and Minimum Wire Size Rating of PV Terminal Block | #6 AWG to #14 AWG (13.5 to 2.5 mm ²) |
| Maximum and Minimum Wire Size Rating of Battery Terminal Block | #2 AWG to #14 AWG (35 to 2.5 mm ²) |
| Wire Size Rating of Auxiliary Output Connector | #16 AWG (1.5 mm ²) |
| Operating Temperature Range (derate above 45 °C) | -20 to +65 °C (-4 to 149 °F) (output power to be derated linearly to zero at 65 °C) |
| Storage Temperature | -40 to +85 °C (-40 to 185 °F) |
| Altitude Limit (operating) | Sea level to 6,500 feet (approximately 2000 m) |
| Dimensions (H × W × D) | 30 × 8 5/8 × 8 5/8" (760 × 220 × 220 mm) |
| Mounting | Vertical wall mount |
| Weight (Controller only) | 29.8 lb (13.5 kg) |
| Weight (Shipping) | 38.3 lb (17.4 kg) |

Output Power Versus Ambient Temperature

Once the unit's heat sink reaches maximum full-power operating temperature, the unit reduces its power output to ensure component ratings are not exceeded.

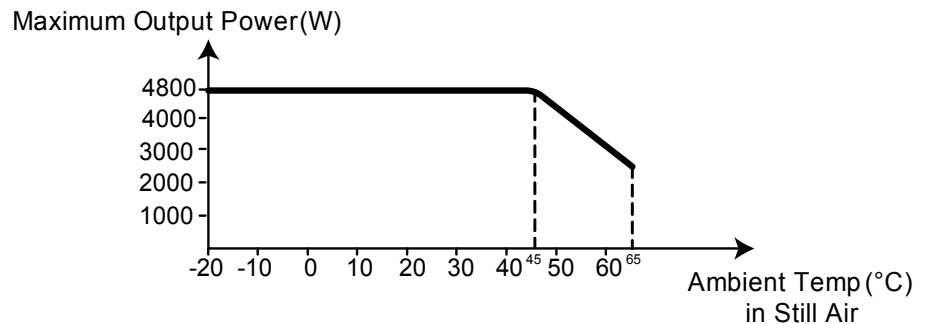

Figure A-4 Output Power vs. Ambient Temperature

Recommended Accessories

The Xantrex XW System Control Panel (865-1050) is strongly recommended for all installations of the unit. It is the primary interface to the unit. Use it for setup, configuration, monitoring, and fault reporting. Only one Xantrex XW SCP is required to monitor multiple units.

Important: You must use a Xantrex XW SCP with firmware version 1.03.00 or higher for full compatibility with the unit. For information on updating your firmware, contact customer service (see “Contact Information” on page ii). The Xantrex XW Config tool will be required.

Optional Accessories

| | |
|------------------------------------------------------------------------------------------------------------------------------------------------------------------|----------|
| Xantrex Gateway | 865-1055 |
| Xantrex Xanbus power supply | 865-1057 |
| Xantrex XW Config (Provides the ability to update system firmware and monitor system status. See “Xantrex XW Config User’s Guide” Part Number 975-0365-01-01) | 865-1155 |

Regulatory Approvals

Certified to UL 1741 and to CSA 107.1 and carries the c(CSA)us mark.

EMC - North America:

- FCC Part-15 sub part B, Class B
- Industry Canada ICES-003, Class B

CE Marked and complies with the following:

Low Voltage Directive 2006/95/EC, per:

- EN50178 *Electronic Equipment for Use in Power Installations.*

EMC Directive 2004/108/EC, per:

- EN61000-6-3 *Emission standard for residential, commercial, and light-industrial environments*
- EN61000-6-1 *Immunity for residential, commercial, and light-industrial environments*

B

Xantrex XW System Control Panel Menus

Appendix B is a guide to the Xantrex XW MPPT 80 600 monitoring and configuration menus on the Xantrex XW System Control Panel.

Using the Xantrex XW SCP

The unit is configured using the Xantrex XW System Control Panel (Xantrex XW SCP). The Xantrex XW SCP has four buttons for navigating between screens and menus and configuring the unit. See Figure B-1 and Table B-1.

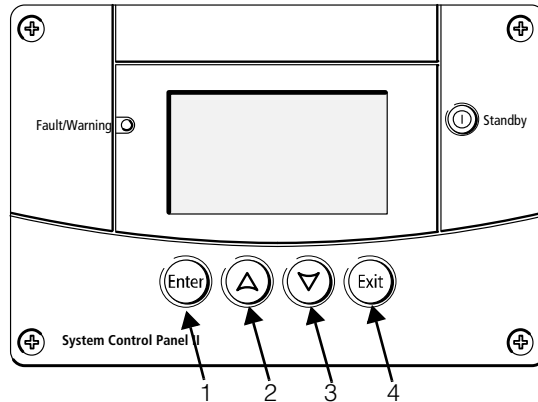

Figure B-1 Xantrex XW System Control Panel

Table B-1 Xantrex XW System Control Panel Navigation Buttons

| Number | Button | Function |
|--------|------------|---------------------------------------------------------------------------------------------------------------------------------------------------------------------------|
| 1 | Enter | <ul style="list-style-type: none"> • Confirms selection of a menu item • Displays the next screen |
| 2 | Up arrow | <ul style="list-style-type: none"> • Scrolls up one line of text • Increases a selected value • Displays the previous Device Home screen |
| 3 | Down arrow | <ul style="list-style-type: none"> • Scrolls down one line of text • Decreases a selected value • Displays the next Device Home screen |
| 4 | Exit | <ul style="list-style-type: none"> • Cancels selection of a menu item • Displays the previous screen |

Xantrex XW SCP Menu Map

Figure B-2 shows how the Xantrex XW SCP screens and menus are organized. The screens and menus are described in Table B-2.

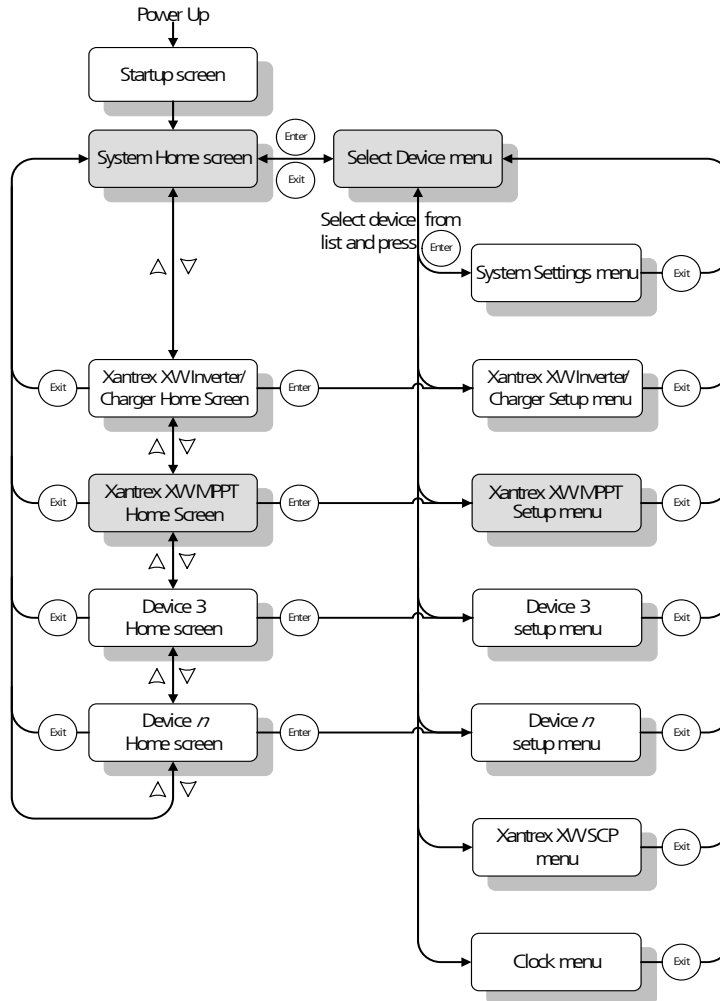

Figure B-2 Xantrex XW SCP Menu Map

Table B-2 Screen and Menu Descriptions

| Screen or menu | Description |
|----------------------|---------------------------------------------------------------------------------------------------------------------------------------------------------------------------------------------------------------------------------------------------------------------------------------------------------------------------------------------------------------------------------------------------------------------------------------------------------------------------------------------------------------------------------------------------------------------------------------------------|
| Startup screen | Appears for a few seconds after the system starts up or when the system has been reset. |
| System Status screen | Displays status information for the power system, consisting of all Xantrex Xanbus-connected devices on a single network. The <code>System Status</code> home screen appearance varies with the status of the inverter/charger and other Xantrex Xanbus-enabled devices in the power system. The <code>System Status</code> home screen features a menu arrow pointing to the Enter button. Pressing Enter takes you to the <code>Select Device</code> menu. |
| XW MPPT Home screen | Displays status information for the unit. |
| Select Device menu | Displays a list of Xantrex Xanbus-enabled devices in the system, including the unit and the Xantrex XW SCP. The length of this menu depends on how many Xantrex Xanbus-enabled devices are installed in the system. This menu also contains the clock menu (where you can set the time and date) and the system settings menu (where you can change system modes). The <code>System Panel</code> , <code>Clock</code> , and <code>System Settings</code> menu items are available from the <code>Select Device</code> menu, regardless of the number of Xantrex Xanbus-enabled devices installed. |
| XW MPPT Setup menu | Displays status information and changeable settings. Changeable settings are identified by square brackets [] around values in the right-hand column. |

Changing Settings Using the Xantrex XW SCP

To change a unit's setting, use the buttons on the Xantrex XW SCP to perform three basic steps:

1. View the `Select Device` menu.
2. Select the unit from the `Select Device` menu.
3. Select and adjust a changeable setting on the unit's `Setup` menu. See page B-8.

Each of these three steps is described in detail in the following sections.

Important: You can also view the unit's `Setup` menu by pressing Enter from the unit's home screen. See "Home Screen" on page B-10.

Viewing the Select Device Menu

The `Select Device` menu is where you select a Xantrex Xanbus-enabled device to monitor or configure. The number of items on the `Select Device` menu depends on how many devices are installed in your Xantrex Xanbus system.

To view the Select Device menu:

- ◆ On the `System Status` screen, press Enter.

Important: You can identify the `System Status` home screen by the menu arrow in the bottom left corner of the screen. The menu arrow indicates the Enter button on the Xantrex XW SCP, which you press to view the `Select Device` menu.

Viewing the Setup Menu

On the `Select Device` menu, select the unit to view and change its settings.

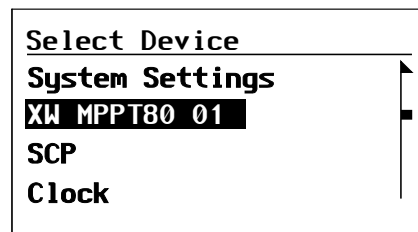

Figure B-3 Selecting the Unit

To select the unit from the Select Device menu:

1. Press the down arrow button to highlight `XW MPPT80 xx`, where `xx` is the device number.
2. Press Enter.
The `Setup` menu appears.

The Setup Menu

The `Setup` menu allows access to the `Meters` screen and several other commands that control the unit's operation.

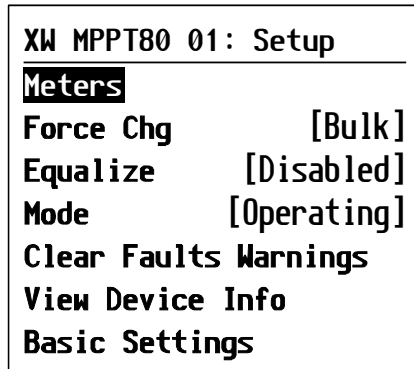

Figure B-4 Setup Menu

Table B-3 Setup Menu

| Menu Item | Description |
|-----------------------|-----------------------------------------------------------------------------------------------------------------------------------------------------------------|
| Meters | Displays the <code>Meters</code> screen. |
| Harvest Logs | Displays the unit's daily, monthly, and yearly performance logs. See "Viewing Harvest Logs" on page 3–11. |
| Force Chg | Causes the current charge stage to change to the selected stage. |
| Equalize | Starts or stops battery equalization. |
| Mode | Sets the unit's operating mode. |
| Clear Faults Warnings | Clears any active faults or warnings. If the fault or warning condition is still present, the fault or warning message may reappear. |
| View Device Info | Displays the <code>Dev Info</code> screen. On the <code>Dev Info</code> screen you can view the warning, fault, and event logs. |
| Basic Settings | Displays the unit's basic or advanced configuration settings. To change to advanced settings, press the Enter, up arrow, and down arrow buttons simultaneously. |

Configuration Settings

Basic menu

The configuration settings can be viewed in basic and advanced formats. The basic settings include configuration items you may have to adjust routinely or as part of initial setup.

Advanced menu

Advanced settings provide access to the full range of settings, including everything displayed on the basic menu. To help protect against unintended advanced configuration, the basic settings are displayed by default. To enable the Xantrex XW SCP to display the advanced settings, you must perform a special keypress. To enable the Advanced menu:

- ◆ Press the Enter, up arrow, and down arrow buttons simultaneously.

The `Basic Settings` item changes to `Advanced Settings`.

After configuring the unit, to help prevent unintended advanced configuration, use this keypress again to hide the advanced menu items.

Important:

- This keypress displays advanced settings for every device in the system.
 - After performing the keypress, `Advanced Settings` appears at the top of the `Setup` menu. When the keypress is performed again, the `Setup` menu displays `Basic Settings` as the last item on the menu.
-

The unit's `Config` menu contain sub-menus for configuring:

- Multiple-unit operation
- Charger and battery settings
- Input settings
- Auxiliary output settings.

To view the Config menu:

- ◆ From the `Setup` menu, with `Basic Settings` Or `Advanced Settings` highlighted, press Enter.

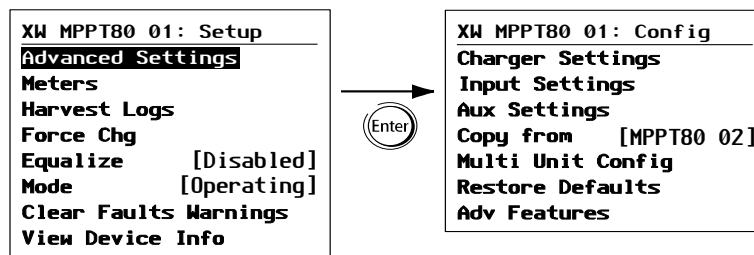

Figure B-5 Selecting the Configure Menu

For a map of all configuration menus, see Figure B-7 on page B-9.

Configurable settings are identified by square brackets [] around the values along the right side of the screen.

To select and change a configurable setting:

1. On the desired configuration menu, press the up arrow or down arrow button to highlight the setting you want to change.
2. Press Enter to highlight the current value of the setting.
3. Press the up arrow or the down arrow button to change the value. Hold down the button to scroll through a large range of values quickly.
The previously set value appears with an asterisk (*) beside it.
4. Press Enter to select the value.
5. If you have another setting to change, return to step 1.

Or

If you have no more settings to change, press Exit until the Xantrex XW SCP displays the desired screen or menu.

To restore the unit's default settings:

1. On the Config menu, select Restore Defaults.
2. Press Enter.

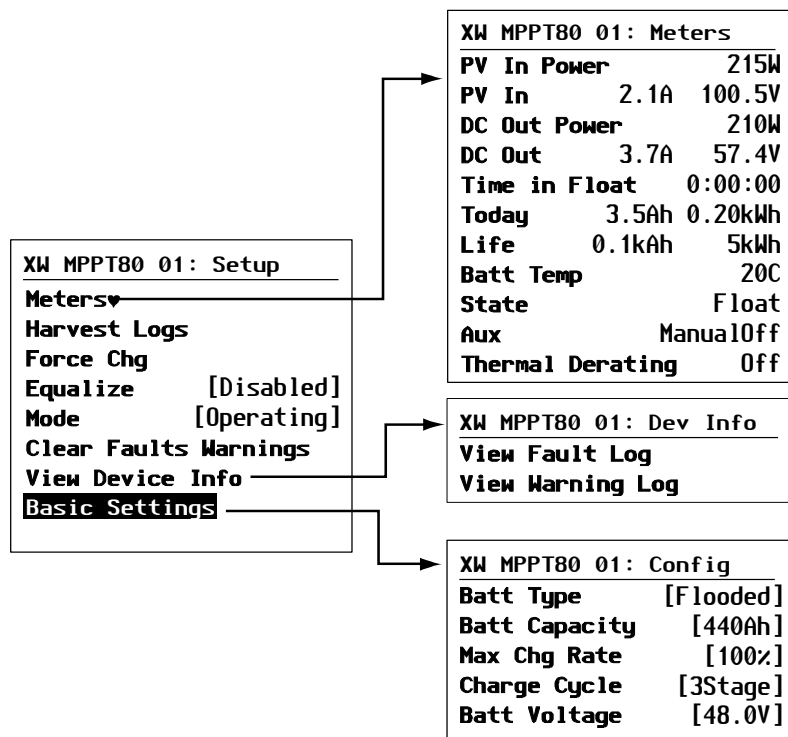

Figure B-6 Configuration Menus (Basic)

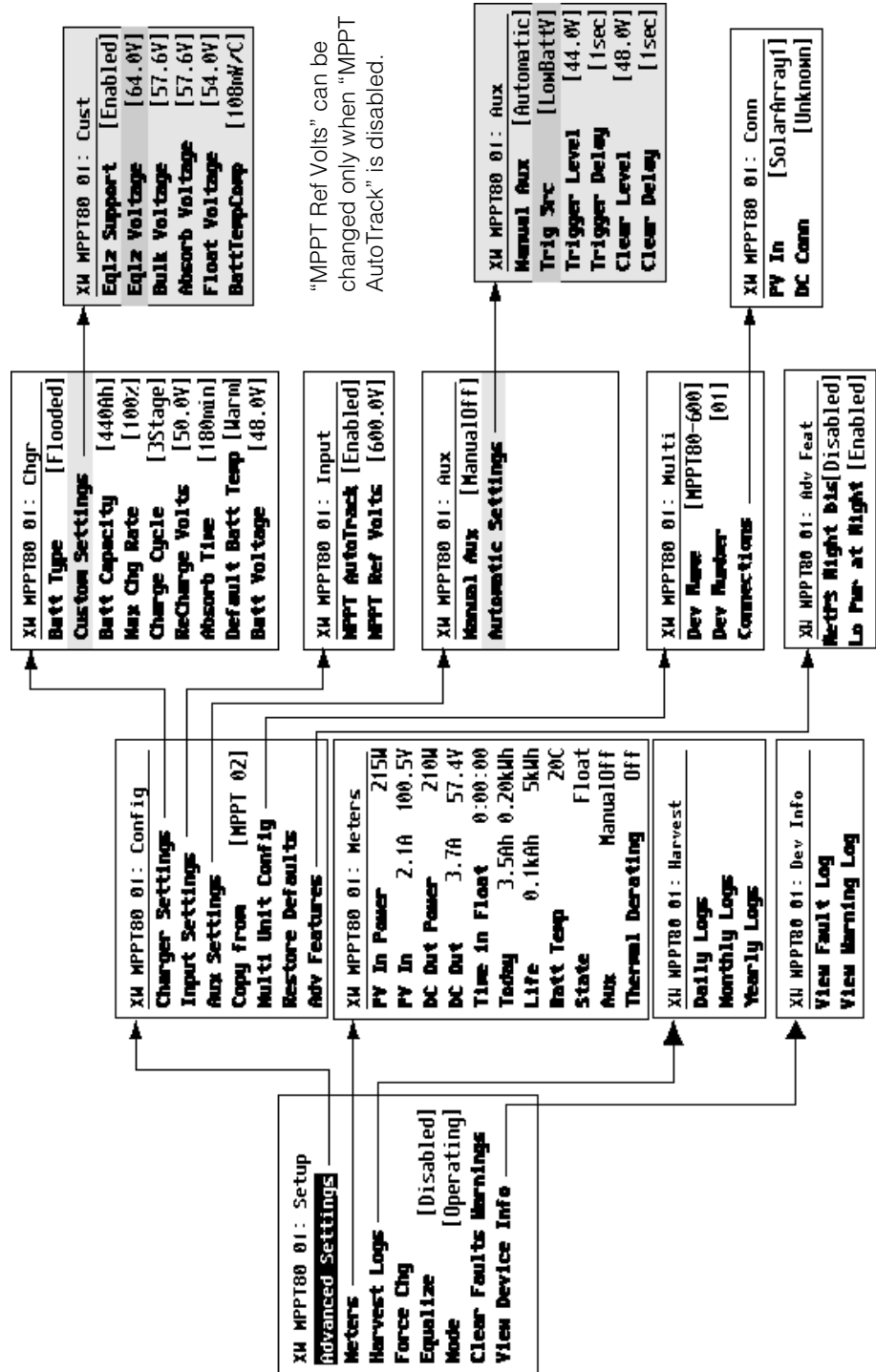

Figure B-7 Configuration Menu (Advanced)

Monitoring the Unit

You can monitor the unit's operation on the Xantrex XW SCP by viewing the:

- Home screen
- Meters screen

Home Screen

The unit's Home screen displays real-time operational data specific to the unit.

To view the unit's Home screen:

- ◆ From the System Status screen, press the down arrow until the unit's Home screen appears.

To return to the System Status screen:

- ◆ Press the Exit button.

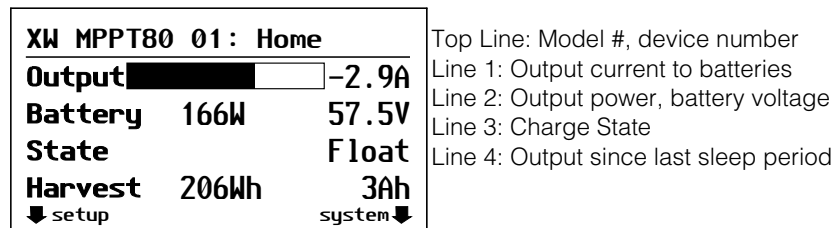

Figure B-8 Home Screen

The unit's Home screen features a `setup` arrow pointing to the Enter button and a `system` arrow pointing to the Exit button. Pressing Enter takes you to the unit's Setup menu. Pressing Exit takes you to the System Status screen.

Pressing the down arrow button takes you to the home screens for the other Xantrex Xanbus-enabled devices in the system.

Meters

Monitor the unit's operation on the **Meters** screen. The **Meters** screen displays input and output power, battery temperature, charge stage, total power production for that day, and power production over the unit's lifetime.

You can select the **Meters** screen from the unit's **Setup** menu.

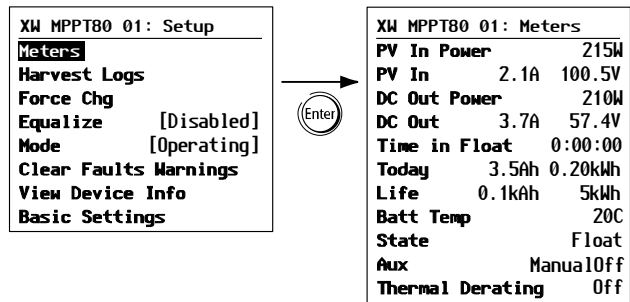

Figure B-9 Selecting the Meters Screen

C

Boost Charging

Appendix C provides information on Boost Charging for flooded lead-acid batteries in off-grid applications.

Using Boost Charging

Boost charging allows for better utilization of flooded lead acid batteries under moderate cycling in off grid applications. Boost charging encourages a short duration charging voltage—above the gassing voltage—at the beginning of the absorption charge state. Testing has shown that boost charging improves battery performance by providing a regular mixing of the liquid electrolyte. Boost charging specifically discourages capacity-robbing acid stratification and plate sulfation.

Boost mode charging can be enabled by selecting the custom battery type and then setting the bulk voltage higher than the absorption voltage. The multi-stage charge algorithm then attempts to use the higher bulk voltage for the first hour of the absorption stage – unless interrupted by the max absorption timer or exit current threshold.

1. Boost charging encourages gassing of flooded lead acid batteries.

| |
|---------------------------------------------------------------------------------------------------------------------------------|
| ⚠ WARNING |
| HAZARD OF EXPLOSION |
| Boost charging generates explosive gases which might escape from the battery. Always make sure battery ventilation is adequate. |
| Failure to follow these instructions can result in death or serious injury. |

2. Boost charging is NOT recommended for AGM, GEL, or any other electrolyte-limited and/or valve regulated sealed battery application.
3. Boost charging may result in higher than normal water consumption. However, the benefits of boost charging are likely to be greater than the extra watering effort. Check battery water levels at least once per month.
4. Boost charging has maximum benefit when used on batteries that experience moderate cycling. An unoccupied cottage, for example, where batteries are full the majority of the time, may not benefit from boost charging – especially if battery watering is difficult.

Warranty and Return Information

Warranty

What does this warranty cover? This Limited Warranty is provided by Xantrex Technology Inc. ("Xantrex") and covers defects in workmanship and materials in your Xantrex XW MPPT 80 600. This warranty period lasts for 5 years from the date of purchase at the point of sale to you, the original end user customer, unless otherwise agreed in writing (the "Warranty Period"). You will be required to demonstrate proof of purchase to make warranty claims.





This Limited Warranty is transferable to subsequent owners but only for the unexpired portion of the Warranty Period. Subsequent owners also require original proof of purchase as described in "What proof of purchase is required?"

What will Xantrex do? During the Warranty Period Xantrex will, at its option, repair the product (if economically feasible) or replace the defective product free of charge, provided that you notify Xantrex of the product defect within the Warranty Period, and provided that Xantrex through inspection establishes the existence of such a defect and that it is covered by this Limited Warranty.

Xantrex will, at its option, use new and/or reconditioned parts in performing warranty repair and building replacement products. Xantrex reserves the right to use parts or products of original or improved design in the repair or replacement. If Xantrex repairs or replaces a product, its warranty continues for the remaining portion of the original Warranty Period or 90 days from the date of the return shipment to the customer, whichever is greater. All replaced products and all parts removed from repaired products become the property of Xantrex.

Xantrex covers both parts and labor necessary to repair the product and return shipment to the customer via a Xantrex-selected non-expedited surface freight within the contiguous United States and Canada. Alaska and Hawaii are excluded. Contact Xantrex Customer Service for details on freight policy for return shipments outside of the contiguous United States and Canada.

How do you get service? If your product requires troubleshooting or warranty service, contact your merchant. If you are unable to contact your merchant, or the merchant is unable to provide service, contact Xantrex directly at:

|  |  |  |  |
|------------------------------------------------------------------------------------|------------------------------------------------------------------------------------|------------------------------------------------------------------------------------|-------------------------------------------------------------------------------------|
| North America | 1 650 351 8237 1 866 519 1470 | 1 925 245 1022 | re.techsupport@schneider-electric.com |
| France | 0 825 012 999 | | fr-re-techsupport@fr.schneider-electric.com |
| Deutschland | +49 (0) 180 575 3 575 | +49 (0) 2102 404 7101 | pv-service@de.schneider-electric.com |
| España | +34 902 101 813 | +34 933 055 026 | es-sat@es.schneider-electric.com |
| L'Italia | +39 035 4151111 | +39 035415 3200 | IT-pronto-contatto@it.schneider-electric.com |

For other country details please contact your local Schneider Electric Sales Representative or visit our website at: <http://www.schneider-electric.com/sites/corporate/en/support/operations/local-operations/local-operations.page>

Direct returns may be performed according to the Xantrex Return Material Authorization Policy described in your product manual. For some products, Xantrex maintains a network of regional Authorized Service Centers. Call Xantrex or check our website to see if your product can be repaired at one of these facilities.

What proof of purchase is required? In any warranty claim, dated proof of purchase must accompany the product and the product must not have been disassembled or modified without prior written authorization by Xantrex.

Proof of purchase may be in any one of the following forms:

- The dated purchase receipt from the original purchase of the product at point of sale to the end user, or
- The dated dealer invoice or purchase receipt showing original equipment manufacturer (OEM) status, or
- The dated invoice or purchase receipt showing the product exchanged under warranty

Warranty and Return Information

What does this warranty not cover? Claims are limited to repair and replacement, or if in Xantrex's discretion that is not possible, reimbursement up to the purchase price paid for the product. Xantrex will be liable to you only for direct damages suffered by you and only up to a maximum amount equal to the purchase price of the product.

This Limited Warranty does not warrant uninterrupted or errorfree operation of the product or cover normal wear and tear of the product or costs related to the removal, installation, or troubleshooting of the customer's electrical systems. This warranty does not apply to and Xantrex will not be responsible for any defect in or damage to:

- a) the product if it has been misused, neglected, improperly installed, physically damaged or altered, either internally or externally, or damaged from improper use or use in an unsuitable environment;
- b) the product if it has been subjected to fire, water, generalized corrosion, biological infestations, or input voltage that creates operating conditions beyond the maximum or minimum limits listed in the Xantrex product specifications including but not limited to high input voltage from generators and lightning strikes;
- c) the product if repairs have been done to it other than by Xantrex or its authorized service centers (hereafter "ASCs");
- d) the product if it is used as a component part of a product expressly warranted by another manufacturer;
- e) component parts or monitoring systems supplied by you or purchased by Xantrex at your direction for incorporation into the product;
- f) the product if its original identification (trade-mark, serial number) markings have been defaced, altered, or removed;
- g) the product if it is located outside of the country where it was purchased; and
- h) any consequential losses that are attributable to the product losing power whether by product malfunction, installation error or misuse.

Disclaimer

Product

THIS LIMITED WARRANTY IS THE SOLE AND EXCLUSIVE WARRANTY PROVIDED BY XANTREX IN CONNECTION WITH YOUR XANTREX PRODUCT AND IS, WHERE PERMITTED BY LAW, IN LIEU OF ALL OTHER WARRANTIES, CONDITIONS, GUARANTEES, REPRESENTATIONS, OBLIGATIONS AND LIABILITIES, EXPRESS OR IMPLIED, STATUTORY OR OTHERWISE IN CONNECTION WITH THE PRODUCT, HOWEVER ARISING (WHETHER BY CONTRACT, TORT, NEGLIGENCE, PRINCIPLES OF MANUFACTURER'S LIABILITY, OPERATION OF LAW, CONDUCT, STATEMENT OR OTHERWISE), INCLUDING WITHOUT RESTRICTION ANY IMPLIED WARRANTY OR CONDITION OF QUALITY, MERCHANTABILITY OR FITNESS FOR A PARTICULAR PURPOSE. ANY IMPLIED WARRANTY OF MERCHANTABILITY OR FITNESS FOR A PARTICULAR PURPOSE TO THE EXTENT REQUIRED UNDER APPLICABLE LAW TO APPLY TO THE PRODUCT SHALL BE LIMITED IN DURATION TO THE PERIOD STIPULATED UNDER THIS LIMITED WARRANTY.

IN NO EVENT WILL XANTREX BE LIABLE FOR: (A) ANY SPECIAL, INDIRECT, INCIDENTAL OR CONSEQUENTIAL DAMAGES, INCLUDING LOST PROFITS, LOST REVENUES, FAILURE TO REALIZE EXPECTED SAVINGS, OR OTHER COMMERCIAL OR ECONOMIC LOSSES OF ANY KIND, EVEN IF XANTREX HAS BEEN ADVISED, OR HAD REASON TO KNOW, OF THE POSSIBILITY OF SUCH DAMAGE; (B) ANY LIABILITY ARISING IN TORT, WHETHER OR NOT ARISING OUT OF XANTREX'S NEGLIGENCE, AND ALL LOSSES OR DAMAGES TO ANY PROPERTY OR FOR ANY PERSONAL INJURY OR ECONOMIC LOSS OR DAMAGE CAUSED BY THE CONNECTION OF A PRODUCT TO ANY OTHER DEVICE OR SYSTEM; AND (C) ANY DAMAGE OR INJURY ARISING FROM OR AS A RESULT OF MISUSE OR ABUSE, OR THE INCORRECT INSTALLATION, INTEGRATION OR OPERATION OF THE PRODUCT BY PERSONS NOT AUTHORIZED BY XANTREX.

CONSUMERS IN THE EUROPEAN UNION:

IF YOU ARE A CONSUMER (RATHER THAN A PURCHASER OF THE PRODUCT IN THE COURSE OF A BUSINESS) AND PURCHASED THE PRODUCT IN A MEMBER STATE OF THE EUROPEAN UNION, THIS LIMITED WARRANTY SHALL BE SUBJECT TO YOUR STATUTORY RIGHTS AS A CONSUMER UNDER THE EUROPEAN UNION PRODUCT WARRANTY DIRECTIVE 1999/44/EC AND AS SUCH DIRECTIVE HAS BEEN IMPLEMENTED IN THE EUROPEAN UNION MEMBER STATE WHERE YOU PURCHASED THE PRODUCT. FURTHER, WHILE THIS LIMITED WARRANTY GIVES YOU SPECIFIC LEGAL RIGHTS, YOU MAY HAVE OTHER RIGHTS WHICH MAY VARY FROM EU MEMBER STATE TO EU MEMBER STATE OR, IF YOU DID NOT PURCHASE THE PRODUCT IN AN EU MEMBER STATE, IN THE COUNTRY YOU PURCHASED THE PRODUCT WHICH MAY VARY FROM COUNTRY TO COUNTRY AND JURISDICTION TO JURISDICTION.

CONSUMERS IN THE REST OF THE WORLD:

Exclusions

If this product is a consumer product, federal law does not allow an exclusion of implied warranties. To the extent you are entitled to implied warranties under federal law, to the extent permitted by applicable law they are limited to the duration of this Limited Warranty. Some states, provinces and jurisdictions do not allow limitations or exclusions on implied warranties or on the duration of an implied warranty or on the limitation or exclusion of incidental or consequential damages, so the above limitation(s) or exclusion(s) may not apply to you. This Limited Warranty gives you specific legal rights. You may have other rights which may vary from state to state, province to province or jurisdiction to jurisdiction.

Return Material Authorization Policy

Before returning a product directly to Xantrex you must obtain a Return Material Authorization (RMA) number and the correct factory "Ship To" address. Products must also be shipped prepaid. Product shipments will be refused and returned at your expense if they are unauthorized, returned without an RMA number clearly marked on the outside of the shipping box, if they are shipped collect, or if they are shipped to the wrong location.

When you contact Xantrex to obtain service, please have your instruction manual ready for reference and be prepared to supply:

- The serial number of your product
- Information about the installation and use of the unit
- Information about the failure and/or reason for the return
- A copy of your dated proof of purchase

Record these details on page WA-4.

Return Procedure

1. Package the unit safely, preferably using the original box and packing materials. Please ensure that your product is shipped fully insured in the original packaging or equivalent. This warranty will not apply where the product is damaged due to improper packaging.
2. Include the following:
 - The RMA number supplied by Xantrex Technology Inc. clearly marked on the outside of the box.
 - A return address where the unit can be shipped. Post office boxes are not acceptable.
 - A contact telephone number where you can be reached during work hours.
 - A brief description of the problem.
3. Ship the unit prepaid to the address provided by your Xantrex customer service representative.

If you are returning a product from outside of the USA or Canada In addition to the above, you MUST include return freight funds and are fully responsible for all documents, duties, tariffs, and deposits.

If you are returning a product to a Xantrex Authorized Service Center (ASC) A Xantrex return material authorization (RMA) number is not required. However, you must contact the ASC prior to returning the product or presenting the unit to verify any return procedures that may apply to that particular facility and that the ASC repairs this particular Xantrex product.

Out of Warranty Service

If the warranty period for your Xantrex XW MPPT 80 600 has expired, if the unit was damaged by misuse or incorrect installation, if other conditions of the warranty have not been met, or if no dated proof of purchase is available, your unit may be serviced or replaced for a flat fee.

To return your Xantrex XW MPPT 80 600 for out of warranty service, contact Xantrex Customer Service for a Return Material Authorization (RMA) number and follow the other steps outlined in "Return Procedure" on page WA-3.

Payment options such as credit card or money order will be explained by the Customer Service Representative. In cases where the minimum flat fee does not apply, as with incomplete units or units with excessive damage, an additional fee will be charged. If applicable, you will be contacted by Customer Service once your unit has been received.

Warranty and Return Information

Information About Your System

As soon as you open your Xantrex XW MPPT 80 600 package, record the following information and be sure to keep your proof of purchase.

- Product Number 865-1032
- Serial Number _____
- Purchased From _____
- Purchase Date _____

If you need to contact Customer Service, please record the following details before calling. This information will help our representatives give you better service.

- Length of time product has been installed _____
 - Battery/battery bank size _____
 - DC wiring size and length _____
 - Warning, Error or Panel Fault Message _____
 - Appliances operating when problem occurred _____
 - Description of problem _____
- _____
- _____

Index

A

- abbreviations v
- Absorb Time setting 2–5
- Absorb Voltage setting 2–6
- absorption charging stage 1–4, 3–4
- accessories
 - optional A–6
 - recommended A–6
- acronyms v
- advanced settings
 - menu map B–9
 - viewing 2–2
- alarm using auxiliary output 1–8
- ambient temperature versus output power A–5
- amp-hour capacity, batteries 2–5
- auxiliary output
 - alarm application 1–8
 - configuring 2–8
 - load control application 1–8
 - overview 1–8
 - trigger source configurable ranges 2–12
 - trigger source descriptions 2–11
 - vent fan application 1–8

B

- Batt Capacity setting 2–5
- Batt Temp setting 2–5
- Batt Type setting 2–4
- Batt Voltage setting 2–4
- batteries
 - amp-hour capacity 2–5
 - boost charging C–2
 - configuring 2–3
 - custom 2–6
 - default charger settings A–4
 - equalization. *See* equalization
 - safety information viii
 - stopping equalization manually 3–14
- battery temperature compensation
 - BTS not connected 2–5
 - overview 1–7, 2–7
- battery temperature sensor 1–7
- BattTempComp setting 2–6
- boost charging C–2
- bulk charging stage 1–4, 3–4
- Bulk Voltage setting 2–6

C

- CAUTION, definition iv
- charge controlling
 - absorption charging stage 1–4, 3–4
 - boost charging C–2
 - bulk charging stage 1–4, 3–4
 - charging current 1–4
 - equalize charging stage 3–4
 - float charging stage 1–5, 3–4
 - manually advance stages 2–5
 - no charge charging stage 3–4
 - no float charging stage 1–6, 3–4
 - overview 1–4
 - three-stage diagram 1–5
 - three-stage overview 1–4
 - two-stage diagram 1–7
 - two-stage overview 1–6
- Charge Cycle setting 2–5
- charge stages 3–4
- charger settings, default A–4
- Clear Delay setting 2–10
- Clear Level setting 2–10
- configurable settings, modifying 2–3
- Copy from setting 2–14
- copying settings 2–14
- custom batteries, setting 2–6

D

- daily logs 3–12
- DANGER, definition iv
- DC Conn setting 2–4
- Default Batt Temp setting 2–5
- default settings, resetting to 2–15, B–8
- Dev Number setting 2–13
- device settings 2–13
- disabling power supplies at night 2–15
- down arrow button, Xantrex XW System Control Panel B–2

E

- electrical specifications A–2
- enter button, Xantrex XW System Control Panel B–2
- Eqlz Support setting 2–6
- Eqlz Voltage setting 2–6

Index

equalization

- charging stage 3–4
- determining when complete 3–14
- enabling 3–14
- overview 1–8, 3–12
- stopping manually 3–14

equalize LED 3–2

Equalize setting 2–4

error/warning LED 3–2

errors

- clear manually 3–5
- messages 3–7
- overview 3–4
- viewing active 3–5
- viewing logs 3–11

exit button

- Xantrex XW System Control Panel B–2

F

F/W Rev setting 2–13

faults

- clear manually 3–5
- disable normal operation 3–5
- messages 3–6
- must be manually cleared 3–5
- overview 3–4
- viewing active 3–5
- viewing logs 3–11

faults and warnings menu 3–4

FCC information viii

float charging stage 1–5, 3–4

Float Voltage setting 2–6

Force Chg setting 2–5

G

Gateway. *See* Xantrex Gateway

green LED 3–2

H

harvest logs

- daily 3–12
- monthly 3–12
- overview 3–11
- requirements 3–11
- yearly 3–12

I

input, configuring 2–7

interference, radio and television reception viii

L

LEDs

- flashing 3–2
- overview 3–2

limitations on use vii

Lo Pwr at Night setting 2–15

load control using auxiliary output 1–8

logs

- daily 3–12
- error 3–11
- fault 3–11
- harvest 3–11
- monthly 3–12
- warning 3–11
- yearly 3–12

M

Manual Aux setting 2–8

manually

- advancing charge stages 2–5
- clearing faults, errors, or warnings 3–5

Max Chg Rate setting 2–5

maximum power point tracking

- maximum power point curve 1–3
- overview 1–3
- voltage range A–3

mechanical specifications A–5

menu maps Xantrex XW System Control Panel

- advanced configuration menu map B–9

messages

- errors 3–7
- faults 3–6
- warnings 3–9

meters screen B–11

Mode setting 2–13

monthly logs 3–12

MPPT AutoTrack setting 2–8

MPPT Ref Volts setting 2–8

MPPT. *See* maximum power point tracking

multiple units, copying settings 2–14

N

NetPS Night Dis setting 2–15

nighttime tare losses 2–15

no float charging stage 1–6, 3–4

not charging, charging stage 3–4

NOTICE, definition iv

O

on/charging LED 3-2
Operating mode 2-13
operating mode, configuring 2-13
optional accessories A-6
orange LED 3-2
output power versus ambient temperature A-5

P

peak power tracking, configuring 2-7
power supplies, disabling at night 2-15
PV In setting 2-8

R

radio reception interference viii
reception interference viii
ReCharge Volts setting 2-5
recommended accessories A-6
red LED 3-2
regulatory approvals A-6
resetting to factory defaults 2-15, B-8
Restore Defaults setting 2-15

S

safety information
 batteries viii
 general vii
SCP. *See* Xantrex XW System Control Panel
settings
 Absorb Time 2-5
 Absorb Voltage 2-6
 Batt Capacity 2-5
 Batt Temp 2-5
 Batt Type 2-4
 Batt Voltage 2-4
 BattTempComp 2-6
 Bulk Voltage 2-6
 Charge Cycle 2-5
 Clear Delay 2-10
 Clear Level 2-10
 Copy from 2-14
 DC Conn 2-4
 Default Batt Temp 2-5
 Dev Number 2-13
 EqLz Support 2-6
 EqLz Voltage 2-6
 Equalize 2-4
 F/W Rev 2-13
 Float Voltage 2-6
 Force Chg 2-5

Lo Pwr at Night 2-15
Manual Aux 2-8
Max Chg Rate 2-5
Mode 2-13
MPPT AutoTrack 2-8
MPPT Ref Volts 2-8
NetPS Night Dis 2-15
PV In 2-8
ReCharge Volts 2-5
Restore Defaults 2-15
Trig Src 2-9
Trigger Delay 2-10
Trigger Level 2-10
specifications
 electrical A-2
 mechanical A-5
Standby mode 2-13
status information
 charge stages 3-4
 LEDs 3-2
 normal operation 3-3
 unit 3-2
 Xantrex XW System Control Panel 3-3
stopping battery equalization 3-14

T

tare losses, reducing 2-15
television reception interference viii
three-stage charge controlling
 diagram 1-5
 overview 1-4
Trig Src setting 2-9
Trigger Delay setting 2-10
Trigger Level setting 2-10
trigger source
 configurable ranges 2-12
 descriptions 2-11
troubleshooting 4-2
two-stage charge controlling
 diagram 1-7
 overview 1-6

U

up arrow button, Xantrex XW System Control Panel
 B-2

V

vent fan using auxiliary output 1-8

W

WARNING, definition iv

warnings

- clear manually 3–5

- messages 3–9

- overview 3–4

- viewing active 3–5

- viewing logs 3–11

warranty WA–1

X

Xantrex Gateway 1–2

Xantrex Xanbus

- disabling at night 2–15

Xantrex XW System Control Panel

- advanced settings display 2–2

- auxiliary output configuration 2–8

- basic configuration menu map B–8

- basic settings 2–2

- battery configuration 2–3

- buttons B–2

- changing settings B–4

- configurable settings 2–3

- custom battery type settings 2–6

- device settings configuration 2–13

- disabling power supplies at night 2–15

- down arrow button B–2

- enter button B–2

- error messages 3–7

- exit button B–2

- fault messages 3–6

- input configuration 2–7

- meters screen B–11

- operating mode configuration 2–13

- peak power tracking configuration 2–7

- reducing tare losses 2–15

- selecting a unit 2–2

- startup screen B–4

- status information 3–3

- system home screen B–4

- up arrow button B–2

- warning messages 3–9





- XW MPPT80 600 home screen B–10

Y

yearly logs, viewing 3–12

Schneider Electric

www.schneider-electric.com

|  |  |  |  |
|-------------------------------------------------------------------------------------|-------------------------------------------------------------------------------------|-------------------------------------------------------------------------------------|-------------------------------------------------------------------------------------|
| North America | 1 650 351 8237 1 866 519 1470 | 1 925 245 1022 | re.techsupport@schneider-electric.com |
| France | 0 825 012 999 | | fr-re-techsupport@fr.schneider-electric.com |
| Deutschland | +49 (0) 180 575 3 575 | +49 (0) 2102 404 7101 | pv-service@de.schneider-electric.com |
| España | +34 902 101 813 | +34 933 055 026 | es-sat@es.schneider-electric.com |
| L'Italia | +39 035 4151111 | +39 035415 3200 | IT-pronto-contatto@it.schneider-electric.com |

For other country details please contact your local Schneider Electric Sales Representative or visit our website at: <http://www.schneider-electric.com/sites/corporate/en/support/operations/local-operations/local-operations.page>.